

RB900

USER MANUAL



GSM / UMTS / LTE



Contents

1. Overview.....	5
2. References.....	6
3. Product variants.....	7
4. Package.....	8
4.1 Box.....	8
5. Complete package contents.....	9
6. General presentation.....	10
6.1 Product pictures	10
6.2 External connections.....	11
6.2.1 GSM antenna connector.....	11
6.2.2 GPS antenna connector.....	11
6.2.3 Memory slot.....	12
6.2.4 USB Interface.....	12
6.2.5 RS232 Interface (EIA574).....	13
6.2.6 RS485 interface.....	14
6.2.7 D-Sub HD 15-pin connector.....	15
6.2.8 Power supply connector.....	17
6.2.9 SIM card holder.....	17
6.3 Product sticker.....	18
7. Basic features and services.....	19
8. Using the modem.....	20
8.1 Setting up the modem.....	20
8.2 Mounting the modem.....	21
8.2.1 On DIN bus.....	21
8.2.2 On the wall.....	22
8.3 Checking the communication with the modem.....	22
8.4 Status of the modem (LEDs).....	23
8.5 Disabling and enabling echo function.....	23
8.6 Verifying the strength of received signal.....	24
8.7 PIN code status.....	24
8.8 Network registration.....	25
8.8.1 GSM network registration.....	25
8.9 GPRS network registration.....	26
8.10 AT commands summary.....	27

9. Troubleshooting.....	28
9.1 No connection/communication with the modem.....	28
9.2 Receiving ERROR message.....	28
9.3 Receiving NO CARRIER message.....	29
10. Technical characteristics.....	30
10.1 Mechanical characteristic.....	30
10.2 Housing description (dimensioning diagram).....	30
11. Electrical characteristic.....	31
11.1 Power supply.....	31
11.2 RF characteristics.....	31
11.3 External antenna.....	33
11.4 Environmental characteristic.....	33
12. Python Script Interpreter.....	34
13. AppZone.....	36
14. RB900-GPS.....	37
15. RB900MODBUS.....	38
16. AT Reference manual.....	39
17. Safety recommendations.....	43
17.1 General Safety.....	43
17.2 Care and Maintenance.....	43
17.3 Responsibility.....	43
18. Accessories.....	44
18.1 Accessories critical for using modem.....	44
18.2 Additional accessories.....	45
19. Conformity Assessment Issues.....	46
20. Safety Recommendations.....	47
21. Certifications.....	49
22. List of Acronyms.....	51
23. Online support.....	53

APPLICABILITY TABLE

Modem	Short description
RB900	Basic GPRS modem
RB900-IO	GPRS modem with GPIO signals
RB900-M	GPRS modem with memory card connector
RB900-GPS	GPRS modem with GPS/Glonass receiver
RB900MODBUS	GPRS modem with Modbus application
RB900U	Basic UMTS modem
RB900U-IO	UMTS modem with GPIO signals
RB900U-M	UMTS modem with memory card connector
RB900U-GPS	UMTS modem with GPS/Glonass receiver
RB900L	Basic LTE modem

1. Overview

The RB900 Terminal is the complete modem solution for wireless m2m applications. Based on the Telit GE910, HE910 or LE910 module, it is available as penta or quad-band version and offers high level GSM/GPRS/HSPA+/LTE features in compact aluminium housing with all the standardized interfaces and optionally GPS receiver, configurable GPIO or memory card to store all measured data. Together with its small size and wide supply voltage range, makes it easy to integrate into all kinds of machines.

The RB900 terminal enabling voice, high speed data transmission, SMS and fax communication is a universal solution for all low-volume M2M and mobile data applications including metering, traffic systems, transportation and logistics, security, vending machines, and facility management.

Device can be controlled by standard AT commands or by customer's application inside (embedded Python Script Interpreter or "C" language), thus making it the smallest, complete SMT platform for m2m solutions.

This document contains full RB900 modem description and gives information about installation and using it.

2. References

- [1] Telit_AT_Commands_Reference_Guide.pdf
- [2] Telit_3G_Modules_AT_Commands_Reference_Guide.pdf
- [3] Telit_LE9x0_AT_Commands_Reference_Guide.pdf
- [4] Telit_GE910_Product_Description.pdf
- [5] Telit_HE910-Series_Product_Description.pdf
- [6] Telit_LE910_Product_Description.pdf
- [7] Telit_Easy_Script_Python.pdf
- [8] Telit_Easy_Script_Python_2.7.pdf
- [9] Telit_IoT_AppZoneC_API_Reference_Guide.pdf
- [10] <http://www.python.org/>

3. Product variants

RB900 modem variants, order codes and its description are listed below.

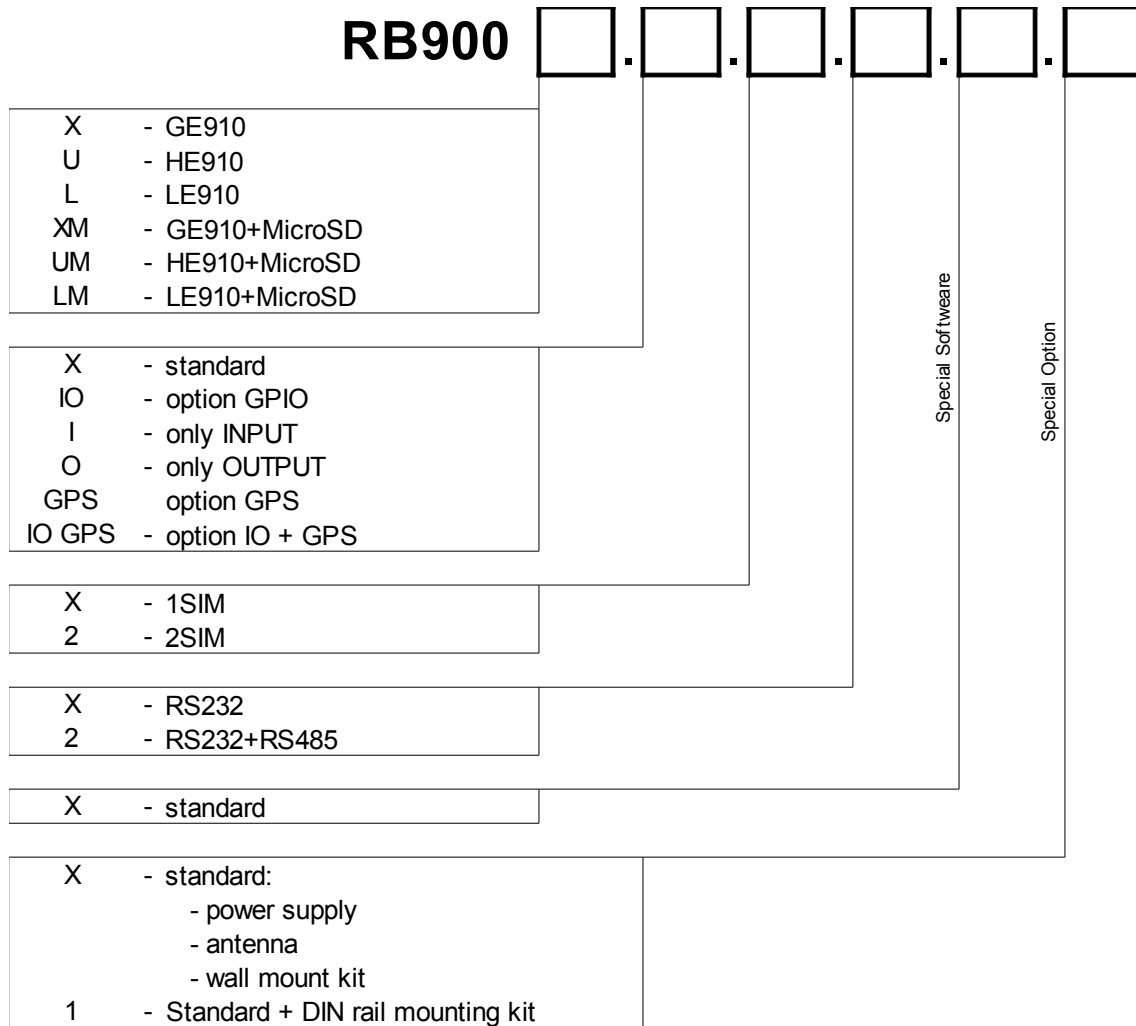

Example:

RB900U.IO.X.X.X.1 – HSPA+ modem with RS232 and IO connector, 1 SIM holder, with DIN rail mounting kit

4. Package

4.1 Box

Original box of the product is shown in the picture below.



There is product sticker on the box. It matches modems sticker that is placed on the device. This proves that your modem is an original product. More information about stickers you can find in [chapter 6.3](#).

5. Complete package contents

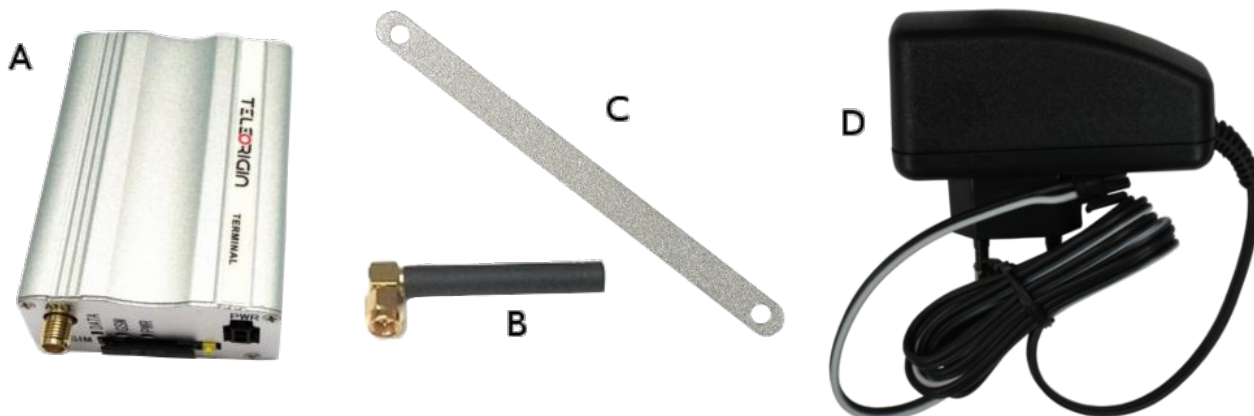

Complete package contains:

- RB900 terminal (item A)
- GSM antenna (SMA connector) (item B)
- wall handle (item C)
- power adaptor (item D)

6. General presentation

6.1 Product pictures

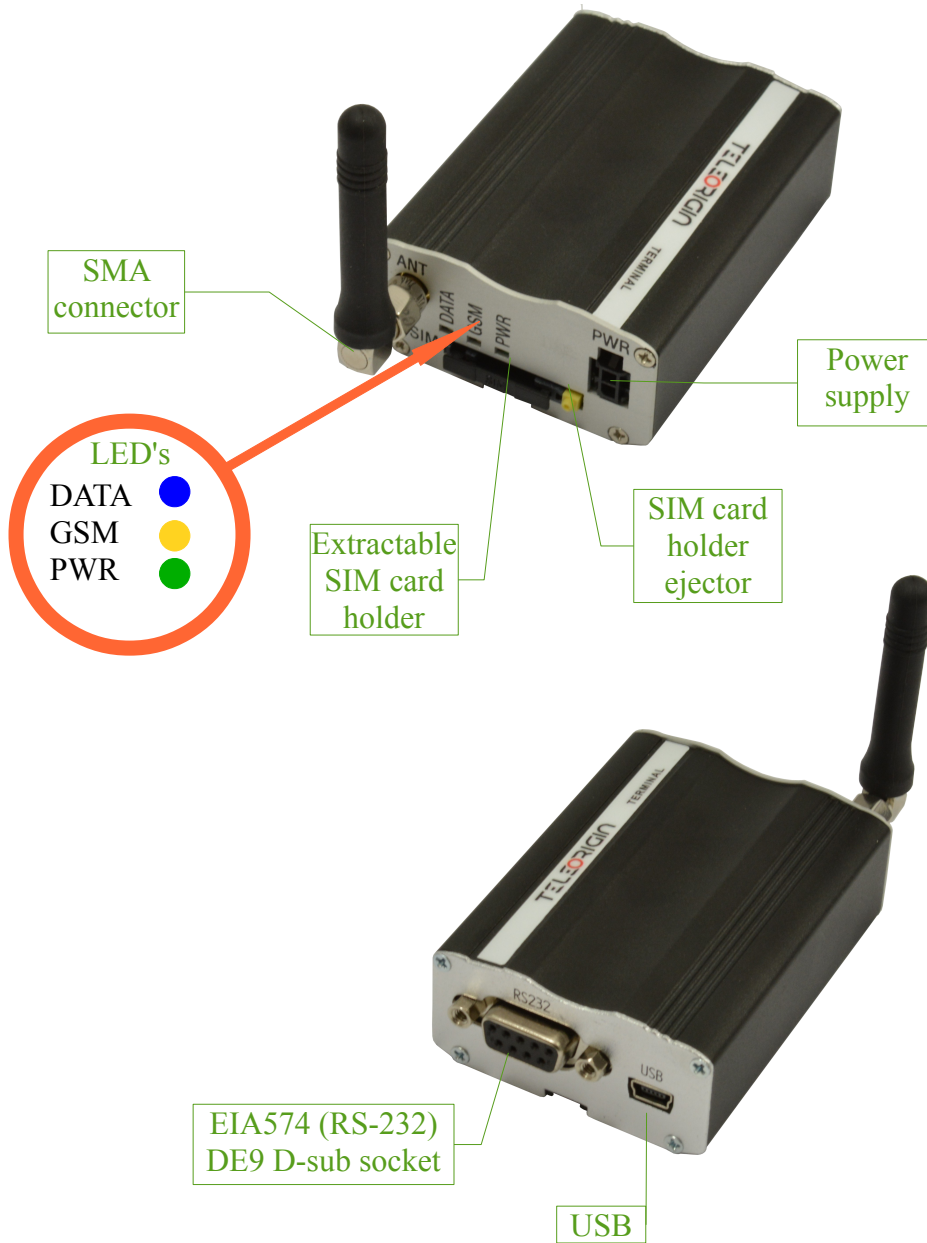

6.2 External connections

6.2.1 GSM antenna connector



SMA “ANT” input is used to connect external GSM antenna. To establish a connection with GSM network an external antenna must be used. Type of antenna depends on GSM coverage. In good circumstances (level of received signal is high) use antenna which is attached in the package. If range of GSM is low or none, an outdoor or indoor (for instance in place where GSM range is sufficient) antenna should be used.

Note: *If there is no antenna connected to SMA connector, the connection with GSM network is impossible.*

6.2.2 GPS antenna connector

SMA “GPS” input is used to connect external GPS antenna. To establish connection with GPS satellites and check the coordinates of device an external antenna must be used and should be located outdoor.



6.2.3 Memory slot



RB900 can be optionally equipped with memory card slot to store all the measured data. The slot type is microSD. Memory card can be controlled only by Python script using special AT commands which is sends through SER2 interface, see chapter AT Reference manual and Python Script Interpreter.

6.2.4 USB Interface

RB900 terminal is equipped with USB interface (as shown below) – miniUSB connector type.



6.2.5 RS232 Interface (EIA574)

RB900 terminal is equipped with RS232 interface (as shown below). DE9 DSUB socket is connected via voltage level translator circuit to the GSM module.



Table of RS232 DB9 pins:

Pin No.	Name	Dir	Description
1	DCD	IN	Data Carrier Detect. Raised by DCE when modem synchronized.
2	RD	IN	Receive Data (a.k.a RxD, Rx). Arriving data from DCE.
3	TD	OUT	Transmit Data (a.k.a TxD, Tx). Sending data from DTE.
4	DTR	OUT	Data Terminal Ready. Raised by DTE when powered on. In auto-answer mode raised only when RI arrives from DCE.
5	SGND	-	Ground
6	DSR	IN	Data Set Ready. Raised by DCE to indicate ready.
7	RTS	OUT	Request To Send. Raised by DTE when it wishes to send. Expects CTS from DCE.
8	CTS	IN	Clear To Send. Raised by DCE in response to RTS from DTE.
9	RI	IN	Ring Indicator. Set when incoming ring detected - used for auto-answer application. DTE raised DTR to answer.

DE-9 (EIA/TIA 574)
looking into female connector

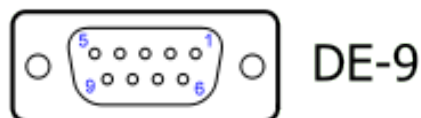

6.2.6 RS485 interface

RB900 terminal can be optionally equipped with RS485 half duplex interface (there can be RS232 or RS485, not simultaneously). DE9 DSUB socket is connected via voltage level translator circuit to the GSM module.



Table of RS485 DB9 pins:

Pin No.	Name	Dir	Description
1	NC	-	Not connected
2	NC	-	Not connected
3	NC	-	Not connected
4	NC	-	Not connected
5	GND	-	Ground
6	DATA+	IN/OUT	
7	NC	-	Not connected
8	NC	-	Not connected
9	DATA-	IN/OUT	

DE-9 (EIA/TIA 574)
looking into female connector

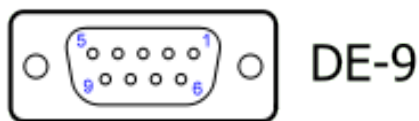

6.2.7 D-Sub HD 15-pin connector

RB900 can be equipped with DE9 15-pin connector to control RS232 interface and GPIO lines. GPIO lines can be controlled by standard AT commands (AT#GPIO) or by internal Python application using MDM.send('AT#GPIO?'r',0) MDM.read() functions. See Python Script Interpreter for details. Below you can find pins description of this variant of modem.

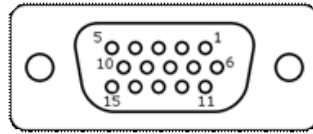

Table of D-Sub HD 15- pin:

Pin no.	Name	Direction	Description
1	GND	-	Ground
2	GPIO3	IN/OUT	GPI3.3V, GPI 5-24V , GPO 5V, GPO 3.3V
3	GPIO8	IN/OUT	GPI3.3V, GPI 5-24V , GPO 5V, GPO 3.3V
4	RTS	IN	Request To Send
5	TX	OUT	Transmit Data
6	GPIO5	IN/OUT	OC, GPI3V3, GPI 5-24V , GPO 5V, GPO 3.3V
7	GPIO6	IN/OUT	GPI3.3V, GPI 5-24V , GPO 5V, GPO 3.3V
8	GPIO2	IN/OUT	GPI3.3V, GPI 5-24V , GPO 5V, GPO 3.3V
9	DTR	IN	Data Terminal Ready
10	GND	-	GND
11	GPIO7	IN/OUT	OC, GPI3V3, GPI 5-24V , GPO 5V, GPO 3.3V
12	GPIO4	IN/OUT	GPI3.3V, GPI 5-24V , GPO 5V, GPO 3.3V
13	GND	-	GND
14	RX	IN	Receive Data
15	CTS	OUT	Clear To Send

GPI3.3V – input, high state 3,3V
 GPI5-24V – input, high state 5-24V
 GPO3.3V – output, high state 3,3V
 GPO5V – output, high state 3,3V
 OC – output, open collector, 160mA, 30V

DE-15 looking into female connector:



Possible GPIO configurations:

- 7 inputs 3.3V
- 7 inputs 5-24V
- 6 inputs 3.3V + power supply on pin 7 (3.3V or device power supply)
- 6 inputs 5-24V + power supply on pin 7 (3.3V or device power supply)
- 6 inputs 3.3V + 1 output OC
- 6 inputs 5-24V + 1 output OC
- 5 inputs 3.3V + 1 output OC + supply on pin 7 (3.3V or device power supply)
- 5 inputs 5-24V + 1 output OC + supply on pin 7 (3.3V or device power supply)
- 5 inputs 3.3V + 2 outputs OC
- 5 inputs 5-24V + 2 outputs OC
- 4 inputs 3.3V + 2 outputs OC + supply on pin 7 (3.3V or device power supply)
- 4 inputs 5-24V + 2 outputs OC + supply on pin 7 (3.3V or device power supply)
- 7 outputs 3.3V
- 7 outputs 5V
- 6 outputs 3.3V + power supply on pin 7 (3.3V or device power supply)
- 6 outputs 5V + power supply on pin 7 (5V or device power supply)
- 6 outputs 3.3V + 1 output OC
- 6 outputs 5V + 1 output OC
- 5 outputs 3.3V + 1 output OC + power supply on pin 7 (3.3V or device power supply)
- 5 outputs 5V + 1 output OC + power supply on pin 7 (5V or device power supply)
- 4 outputs 3.3V + 2 outputs OC + power supply on pin 7 (3.3V or device power supply)
- 4 outputs 5V + 2 outputs OC + power supply on pin 7 (5V or device power supply)

6.2.8 Power supply connector

The power supply connector is a 2-pin connector for external DC power supply connection, which can handle voltage from range 5..30 V DC, 2.5 W max. continuous power.



No.	Signal	I/O	Description
+	V+BATTERY	I	5 V – 30 V DC
-	GND	-	Ground

Attention!

An attempt to power terminal from DC source outside of 5..30 V range may result in physical destruction of the device.

6.2.9 SIM card holder

SIM card holder is placed in front of RB900 terminal (as shown below) and is accessible externally. To insert SIM card into the holder press the **yellow button**, eject the little drawer, place the SIM card and insert drawer into the modem (you will hear „click”). To operate the module in a GSM network, it is necessary to insert a SIM card obtained from the network operator.



6.3 Product sticker

Product stickers are on the modem and on the box of the product. A production sticker includes the following information:

- product serial number (IMEI)
- the CE marking
- the 15-digit bar code
- the model signature



Device sticker



Box sticker

7. Basic features and services

Basic features and available services for RB900 are contained in table below.

Feature/service	Description
Standard	<p>Supported Bands:</p> <p><u>LTE variant:</u></p> <p>EU version:</p> <ul style="list-style-type: none"> - 800/1800/2600 Mhz LTE - 900/2100 Mhz UMTS - 850/900/1800/1900 Mhz GSM/GPRS/EDGE <p>NA variant:</p> <ul style="list-style-type: none"> - 700/850/AWS1700/1900 Mhz LTE - 850/1900 Mhz UMTS - 850/1900 Mhz GSM/GPRS/EDGE <p><u>HSPA+ variant:</u></p> <p>EU version:</p> <ul style="list-style-type: none"> - 800/850/900/2100 Mhz UMTS - 850/900/1800/1900 Mhz GSM/GPRS/EDGE <p>NA variant</p> <ul style="list-style-type: none"> - 800/850/AWS1700/1900 Mhz UMTS - 850/900/1800/1900 Mhz GSM/GPRS/EDGE <p><u>GPRS variant:</u></p> <ul style="list-style-type: none"> - GSM/GPRS 850/900/1800/1900 Mhz <p>Physical:</p> <ul style="list-style-type: none"> - 83 x 53,5 x 25 mm - Weight 151 g
Speed	<p><u>LTE variant:</u></p> <p>LTE cat. 4:</p> <ul style="list-style-type: none"> - up to 100 Mbps downlink - up to 50 Mbps uplink <p><u>HSPA+ variant:</u></p> <p>HSPA category 6 in uplink and up to category 14 in downlink</p> <ul style="list-style-type: none"> - HSDPA up to 21.0 Mbps - HSUPA up to 5.76 Mbps
Interfaces	<p>Connectors</p> <ul style="list-style-type: none"> - SMA for GSM antenna - SMA for GPS antenna (option) <p>SIM Card</p> <ul style="list-style-type: none"> - 3.0V / 1.8V - STK 3.1 <p>Connectivity</p> <ul style="list-style-type: none"> - USB 2.0 HS - UART: BR from 300 bps to 115.2 Kbps - Auto BR
SMS	<ul style="list-style-type: none"> - MO / MT Text and PDU mode - Cell broadcast - SMS over GPRS
GSM supplementary services	<ul style="list-style-type: none"> - TCP/IP, UDP/IP, SMTP, FTP protocolss - USSD phase II
Power supply	5V – 30V DC

8. Using the modem

8.1 Setting up the modem

To set up the modem, do the following steps:

- Eject SIM card holder using yellow button and pull out the drawer.



- Insert Your SIM card into drawer.



- Verify if SIM card fits in the drawer properly (as shown).
- Insert the drawer into the modem.

- Connect the antenna to the SMA connector
- Optionally it can be connected using RS-232 and miniUSB cables
- Plug the power supply cable to the power supply input



- Now the modem is ready to work.

8.2 Mounting the modem

8.2.1 On DIN bus

To mount modem on DIN bus install DIN handle as shown below



8.2.2 On the wall

To mount modem on the wall install wall handles as shown below.



8.3 Checking the communication with the modem

Once the modem is connected you can check communication between RB900 terminal and the PC using Telit AT Controller available here:

http://www.teleorigin.com/file_upl/pliki/1/Telit_AT_Controller_r3_4_4.zip

You can use any Terminal program also. Configuration of the DTE (port COM) should be as follows:

- Bits per second: **115200 bps**,
- Data bits: **8**,
- Parity: **None**,
- Stop bits: **1**,
- Flow control: **hardware**.

To communicate with modem use software such as Hyperterminal (AT commands) or use attached Telit AT Controller.

Using a communication software such as Hyperterminal, enter the **AT** and push 'enter' button. The response of the terminal should be '**OK**' displayed in the Hyperterminal window.

If the connection with the modem cannot be established do the following:

- Check if modem is connected with PC via RS-232 or USB.
 - Check the configuration of the COM port.
- Examples of AT commands:
- **ATE1** enables modem echo function,
 - **AT+CGMI** modem answers "Motorola" when connection is OK.
 - **AT+CPIN?** shows current status of SIM card
 - **AT+CPIN=xxxx** to enter PIN, where 'xxxx' are digitals

- **AT+CSQ** to verify received signal strength
- **ATD<phone_number>**; to initiate a voice call
- **ATH** to hang up a voice call

For further information about AT commands and their usage, refer to [1].

8.4 Status of the modem (LEDs)

The operational status of the RB900 Terminal is signaled by external LEDs placed on the front panel of the modem.

The table below shows what is the meaning of LEDs.

LED name	LED color	Description
DATA	blue	Software controlled: AT#GPIO=6,1,1 – diode ON, AT#GPIO=6,0,1 – diode OFF for all RB900 variants except RB900-IO and RB900U-IO AT#GPIO=9,1,1 – diode ON, AT#GPIO=9,0,1 – diode OFF for RB900-IO and RB900U-IO modem variants
GSM	orange	Software controlled using AT#SLED (GPRS modem variant) or AT#GPIO=8 and AT#SLED (UMTS modem variant): Blinking every second – modem is not logged on to GSM network Blinking every 3 seconds – modem is logged on to GSM network.
PWR	green	Lights when modem is power on

8.5 Disabling and enabling echo function

If echo is not displayed when entering AT command, that means:

- The local echo function in software (such as Hyperterminal) is disabled
- The echo function of the modem is disabled

To enable echo function of the modem enter **ATE1** command.

In Machine to Machine communication it is recommended to disable echo function (type **ATE0**) in order to avoid useless CPU processing.

For further information about **AT** commands and their usage, refer to [1].

8.6 Verifying the strength of received signal

RB900 terminal can establish connection with network if the received signal strength is sufficiently strong.

To verify the signal strength and bit error rate, do the following:

Using software such as Hyperterminal enter **AT+CSQ**. This command displays the received signal strength indication <rss> and channel bit error rate <ber>. The modem answers as follows:

```
+CSQ: <rss>,<ber>
OK
```

<parameter>	Description
<rss>	0 through 31 - covers the range of -113 dbm (or less) to -51dbm (or greater)
<ber>	Channel bit error rate (in percent) 0-7 RXQUAL values in the GSM 05.08 table 99 Unknown or not detectable

For further information about **AT** commands and their usage, refer to [1].

8.7 PIN code status

To check PIN code status enter **AT+CPIN?** Command.

The table below shows the most interesting responses of the modem:

Answer	Description
+CPIN: SIM PIN	PIN code has not been entered
+CPIN: READY	PIN code has been entered correctly

For further information about **AT** commands and their usage, refer to [1].

8.8 Network registration

8.8.1 GSM network registration

To check *GSM* network registration status enter **AT+CREG?** into software (for instance Hyperterminal) Modem will answer in following format:

```
+CREG: <n>,<stat>[,<lac>,<ci>]
OK
```

The following table shows the **+CREG** parameters:

<parameter>	Description
<n>	0 Disables the network registration unsolicited result code. 1 Enables the network registration unsolicited result code +CREG: <stat>. 2 Enables the network registration and location information in unsolicited reports and Read command +CREG:<stat>[,<lac>,<ci>]. The <u>default</u> is 0 .
<stat>	0 Not registered, and the ME is not currently searching for a new operator to which to register. 1 Registered, home network. 2 Not registered, but the ME is currently searching for a new operator to which to register. 3 Registration denied.* 4 Unknown. 5 Registered, roaming.
<lac>	Two-byte location area code in hexadecimal format
<ci>	Two-byte cell ID in hexadecimal format.

*To manage connecting to network SIM card inserted into the modem must be valid. For further information about **AT** commands and their usage, refer to [1].

8.9 GPRS network registration

To check *GPRS* network registration status enter **AT+CGREG?** into software (for instance Hyperterminal) Modem will answer in following format:

```
+CGREG: <n>,<stat>[,<lac>,<ci>]
OK
```

The following table shows the **+CGREG** parameters:

<parameter>	Description
<n>	0 Disables the network registration unsolicited result code. 1 Enables the network registration unsolicited result code +CGREG: <stat>. 2 Enables the network registration and location information in unsolicited reports and Read command +CGREG:<stat>[,<lac>,<ci>]. The <u>default</u> is 0 .
<stat>	0 Not registered, and the ME is not currently searching for a new operator to which to register. 1 Registered, home network. 2 Not registered, but the ME is currently searching for a new operator to which to register. 3 Registration denied.* 4 Unknown. 5 Registered, roaming.
<lac>	Two-byte location area code in hexadecimal format
<ci>	Two-byte cell ID in hexadecimal format.

*To manage connecting to network SIM card inserted into the modem must be valid.

For further information about **AT** commands and their usage, refer to [1].

8.10 AT commands summary

As a conclusion table below shows most common and useful AT commands.

For more AT commands refer to [1].

Action	Syntax	Response	Comments
Echo enable	ATE1	OK	Typed text is seen.
Echo disable	ATE0	OK	Typed text is not seen.
Voice call	ATD<phoneNo>; Remember of ';'.	OK	Call initiated.
		NO CARRIER/BUSY/NO ANSWER	Connection failure.
		+CME ERROR: <err>	General error*
		OPERATION NOT ALLOWED	Security reason (such as SIM card not inserted)
		UNKNOWN CALLING ERROR	Unknown reason
Hung up call	ATH	NO CARRIER	Connection is hanged up.
Receiving call	ATA	OK	Call is answered.
Communication loss		NO CARRIER	
Enter PIN code	AT+CPIN=[<puk> or <pin>], [<newpin>]	OK	Set PIN or PUK or new PIN code.*
		+CME ERROR: <err>	General error*
Check PIN code status	AT+CPIN?	+CPIN: <code>	Returns status of PIN.
		OK	e.g. READY or SIM PIN
		+CME ERROR: <err>	General error*

*Refer to [1], [2] and [3].

9. Troubleshooting

9.1 No connection/communication with the modem

If there is no communication with the modem do the following steps:

- Check all external connections of the modem (RS-232 or USB, Power supply)
- Verify if power supply is correct (see Power supply Power supply)
- Check if COM port is correctly parametrized
- Check if program used for communication works properly and if there is none other program interfering. If yes close the interfering program.

9.2 Receiving ERROR message

Modem answers **ERROR** on AT command in following cases:

- Syntax of typed AT command is incorrect – check the command syntax in [1]
- Parameters of typed AT command are incorrect – type **AT+CME=1** for enabling wide description of error which occurred. The response now will be in format:

ERROR

+CME ERROR: <err>

where <err> is a description of error which has occurred

Refer to [1] for further details about occurred error

9.3 Receiving NO CARRIER message

There are some common cases when modem answers **NO CARRIER**:

- If data/voice/fax connection cannot be established
- Right after hanging up the data/voice/fax connection
- If there is no connection with network – check antenna and registration status (see Network registration Network registration)
- If there is no power supply (see Power supply Power supply)

If modem answers **NO CARRIER** in some cases, you can have extended error code using **AT+CEER**. The table below shows some of codes which can appear.

Error code	Description
1	Unassigned or unallocated number
3	No route to destination
6	Channel unacceptable
8	Operator determined barring
16	Normal call clearing
17	User busy
18	No user responding
19	User alerting, no answer
21	Call rejected
22	Number changed
27	Destination out of order
28	Invalid number format (incomplete number)
34	No circuit/channel available
38	Network out of order
41	Temporary failure

For further information about **AT** commands and their usage, refer to [1].

10. Technical characteristics

10.1 Mechanical characteristic

Max. dimensions	72 x 53.5 x 26 mm (w/o connectors) 83 x 53.5 x 26 mm (w/ connectors)
Weight	≈ 89 g
Volume	100 cm ³ (w/o connectors)

10.2 Housing description (dimensioning diagram)

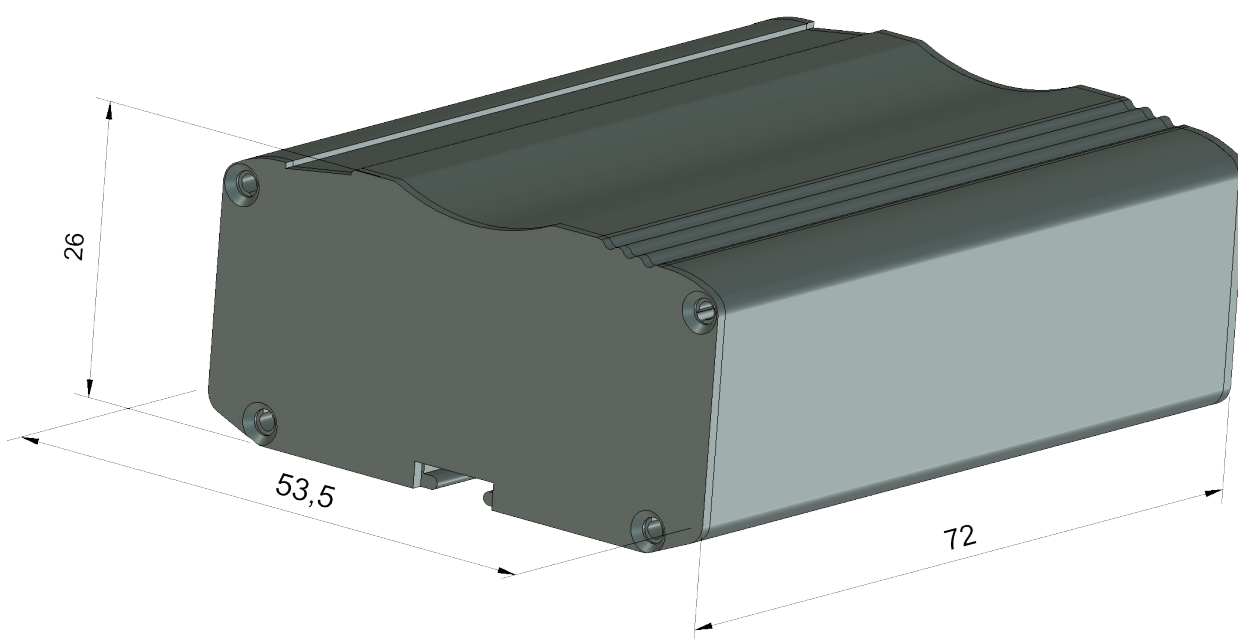

11. Electrical characteristic

11.1 Power supply

- Nominal voltage range: 5..30 V, 10%
- Maximum continuous (average) supply power: 2.5 W
- Maximum continuous (average) supply current: 200 mA at 12V, 100 mA at 24V

11.2 RF characteristics

GPRS variant:

Mode	Freq. TX (MHz)	Freq. RX (MHz)	Channels (ARFC)	TX - RX offset
GSM 850	824.2 – 848.8	869.2 – 893.8	124 – 251	45 MHz
EGSM 900	890.0 – 914.8	935.0 – 959.8	0 – 124	45 MHz
	880.2 – 889.8	925.2 – 934.8	975 – 1023	45 MHz
DCS-1800	1710.2 – 1784.8	1805.2 – 1879.8	512 – 885	95 MHz
PCS-1900	1850.2 – 1909.8	1930.2 – 1989.8	512 – 810	80 MHz

LTE variant:

Mode	Freq. TX (MHz)	Freq. RX (MHz)	Channels	TX - RX offset
EGSM900	890.0 ~ 915	935.0 ~ 959.8	0 ~ 124	45 MHz
	880.2 ~ 889.8	925.2 ~ 934.8	975 ~ 1023	45 MHz
DCS1800	1710.2 ~ 1784.8	1805.2 ~ 1879.8	512 ~ 885	95MHz
WCDMA2100 – B1	1922.4 ~ 1977.6	2112.4 ~ 2167.6	Tx: 9612 ~ 9888 Rx: 10562 ~ 10838	190MHz
WCDMA1900 – B2	1852.4 ~ 1907.6	1932.4 ~ 1987.6	Tx: 9262 ~ 9538 Rx: 9662 ~ 9938	80MHz
WCDMA1800 – B3	1710 ~ 1785	1805 ~ 1880	Tx: 937 ~ 1288 Rx: 1162 ~ 1513	95MHz
WCDMA850 – B5	826.4 ~ 846.6	871.4 ~ 891.6	Tx: 4132 ~ 4233 Rx: 4357 ~ 4458	45MHz
WCDMA900 – B8	882.4 ~ 912.6	927.4 ~ 957.6	Tx: 2712 ~ 2863 Rx: 2937 ~ 3088	45MHz
LTE2100 – B1	1920 ~ 1980	2110 ~ 2170	Tx: 18000 ~ 18599 Rx: 0 ~ 599	190MHz
LTE1900 – B2	1850 ~ 1910	1930 ~ 1990	Tx: 18600 ~ 19199 Rx: 600 ~ 1199	80MHz
LTE1800 – B3	1710 ~ 1785	1805 ~ 1880	Tx: 19200 ~ 19949 Rx: 1200 ~ 1949	95MHz
LTE1700 – B4	1710~ 1755	2110 ~ 2155	Tx: 19950 ~ 20399 Rx: 1950 ~ 2399	400MHz
LTE850 – B5	824 ~ 849	869 ~ 894	Tx: 20400 ~ 20649 Rx: 2400 ~ 2649	45MHz
LTE700 – B17	704 ~ 716	734 ~ 746	Tx: 23730 ~ 23849 Rx: 5730 ~ 5849	30MHz

HSPA + variant:

Mode	Freq. TX (MHz)	Freq. RX (MHz)	Channels	TX - RX offset
GSM850	824 ~ 849	869 ~ 894	128 ~ 251	45 MHz
EGSM900	890 ~ 915	935 ~ 960	0 ~ 124	45 MHz
	880 ~ 890	925 ~ 935	975 ~ 1023	45 MHz
DCS1800	1710 ~ 1785	1805 ~ 1880	512 ~ 885	95MHz
PCS1900	1850 ~ 1910	1930 ~ 1990	512 ~ 810	80MHz
WCDMA800 * [band VI]	830-840	875-885	Tx: 4162 ~ 4188 Additional: 812, 837 Rx: 4387 ~ 4413 Additional: 1037, 1062	45MHz
WCDMA800 * [band XIX]	830-845	875-890	Tx: 312-363 Additional: 387, 412, 437 Rx: 712-763 Additional: 787, 812, 837	45MHz
WCDMA850 [band V]	824 ~ 849	869 ~ 894	Tx: 4132 ~ 4233 additional 782, 787, 807, 812, 837, 862 Rx: 4357 ~ 4458 additional 1007, 1012, 1032, 1037, 1062, 1087	45MHz
WCDMA900 [band VIII]	880 ~ 915	925 ~ 960	Tx: 2712 ~ 2863 Rx: 2937 ~ 3088	45MHz
WCDMA1700 [band IV]	1710 ~ 1755	2110 ~ 2155	Tx: 1312 ~ 1513 additional 1662, 1687, 1712, 1737, 1762, 1787, 1812, 1837, 1862 Rx: 1537 ~ 1738 additional 1887, 1912, 1937, 1962, 1987, 2012, 2037, 2062, 2087	400MHz
WCDMA1900 [band II]	1850 ~ 1910	1930 ~ 1990	Tx: 9262 ~ 9538 additional 12, 37, 62, 87, 112, 137, 162, 187, 212, 237, 262, 287 Rx: 9662 ~ 9938 additional 412, 437, 462, 487, 512, 537, 562, 587, 612, 637, 662, 687	80MHz
WCDMA2100 [Band I]	1920 ~ 1980	2110 ~ 2170	Tx: 9612 ~ 9888 Rx: 10562 ~ 10838	190MHz

11.3 External antenna

The external antenna is connected to the modem via SMA connector.

Antenna must have parameters as shown below in table.

Antenna frequency range	Supporting GSM, UMTS or LTE frequencies
Impedance	50 Ω
DC impedance	0 Ω
Gain	0 dBi w/o cable; 2dBi w/ cable
VSWR (with cable)	-10 dB

The antenna chosen for working with modem should best fit to circumstances of environment it is used in. When the modem is placed in a room or somewhere where the range of networks signal is too low, the outdoor or specific indoor antenna should be used to increase it.

11.4 Environmental characteristic

Table below gives the environmental operating conditions of RB900 terminal.

Attention!

Exceeding the values may result in permanent damage to the module.

Parameter	Conditions	Min	Max	Unit
Ambient Operating Temperature		-20	60	°C
Storage Temperature		-40	85	°C
ESD	At antenna connector Contact Air At interface connector		± 6 ± 15 ± 1	KV
Humidity		5	85	%

12. Python Script Interpreter

The Easy Script Extension is a feature that allows driving the modem internally, writing the controlling application directly in the Python high level language. Python feature is available in GPRS and HSPA+ modem variants only.

A typical application usually consists of a microcontroller managing several I/O pins on the module through the AT command interface. The Easy Script Extension functionality lets the developer to get rid of the external controller and further simplify the programmed sequence of operations. The equipped Python version features the following:

- Python script interpreter engine v.2.7.2
- 2 MB of Non Volatile Memory space for user scripts and data
- 2 MB RAM reserved for the Python engine

The following depicts a schematic of this approach:

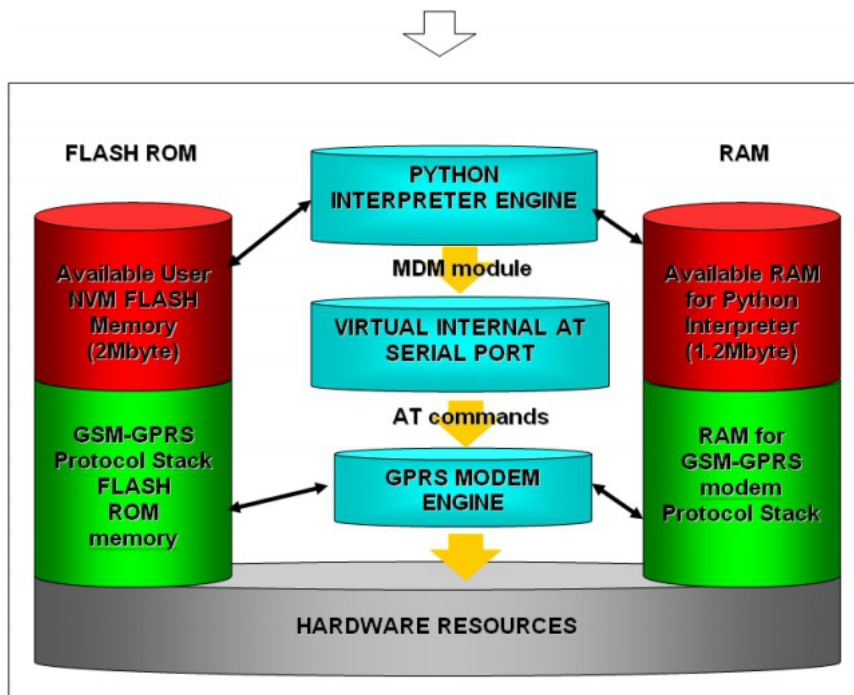

To use Python language features on Telit module use PythonWin. It is an Python editor for Windows. In order for the software to function correctly, it is required the use of either Windows 2000, XP, Vista or 7 as operating systems.

PythonWin can be found here <http://www.python.org/download/windows/>

Python scripts are text files stored in Telit module NVM (Non Volatile Memory). There is a file system inside the module that allows to write and read files with different names on one single level (no subdirectories are supported)

The Python script is executed in a task with the lowest priority on the Telit module, so it's execution won't interfere with GSM/GPRS normal operations. Furthermore, this allows serial ports, protocol stack etc. to run independently from the Python script. The Python script interacts with the Telit module functionalities through several built-in interfaces, as depicted below:

- **The MDM interface** is the most important one. It allows the Python script to send AT commands, receive responses and unsolicited indications, send data to the network and receive data from network during connections. It is quite similar to the regular serial port interface on the Telit module. The only difference being that this interface is an internal software bridge between Python and module internal AT command handling engine, and not a physical serial port. All AT commands working on the Telit module are working with this software interface as well.
- **The MDM2 interface** is the second interface between Python and the module internal AT command handling. It's purpose is to send AT commands from the Python script to the module and receive AT responses from the module to the Python script when the regular MDM built-in module is already in use.
- **The SER interface** lets the Python script to read from and write to the physical serial port ASC0, usually the default port to send AT commands to the module (e.g. to read information from an external device). When Python is running, this serial port is free to be use by the Python script since it is not used as the AT command interface; the AT parser, in fact, is mapped into the internal virtual serial port. No flow control is available from Python on this port.
- **The SER2 interface** lets Python script to read from and write to the physical serial port ASC1, usually the default port for tracing and debugging.
- **The GPIO interface** lets the Python script to handle general purpose input output faster than through AT commands, skipping the command parser and controlling directly the pins.
- **The MOD interface** is a collection of useful functions like timeouts, watchdogs etc.
- **The I2C interface** is an implementation on the Python core of the IIC bus Master. It allows Python to create one or more IIC bus on the available GPIO pins.
- **The SPI interface** is an implementation on the Python core of the SPI bus Master. It allows Python to create one or more SPI bus on the available GPIO pins.
- **The GPS interface** is the interface between Python and the module's internal GPS controller. Its purpose is to handle the GPS controller without the use of dedicated AT commands through the MDM built-in module.

Visit Python official web site for more information <http://www.python.org/>. More information can be found also in [7] and [8]



13. AppZone

AppZone is a Telit's software layer built on the top of the basic software of the module that provides a set of interfaces to the most of the module functionalities, e.g.: GSM/GPRS services and hardware resources. The AppZone layer allows the M2M "C" language application of the customer to run on the CPU of the module. This solution does not require an external application processor to run the customer application. **AppZone feature is available in GPRS modem variant only.**

The customer can develop an M2M application that addresses a wide range of different applications such as remote monitoring and control, security and surveillance, telemetry, location services, billing, fleet management, etc. The application, running on the CPU of the module, via the AppZone API [9] can access the module resources hereunder specified:

- Operating System: Signals, Semaphores, Timers, Dynamic Memory Management, etc.
- HW/SW resources: GPIO, I2C, RS232, File-System, Keypad, RTC, etc.
- GSM/GPRS: Access and control of the communication services.
- Networking: BSD socket support, SSL capabilities.

Refer to document [9] for information on module hardware resources.

14. RB900-GPS

RB900-GPS modem variant includes high-precision combo GPS+Glonass receiver with external antenna. GPS antenna connector type is SMA. Below is the short characteristic and parameters of GPS/Glonass receiver.

Frequency bands: GPS (L1), Glonass (L1, FDMA), Galileo (E1)

Standards: NMEA, RTCM

32 Channel GPS architecture

Sensitivity:

- Acquisition: -146 dBm
- Navigation: -160 dBm
- Tracking: -162 dBm

Positional accuracy (CEP50): 1,5m

Accuracy:

- Speed: <0,05 m/s
- Heading: <0,01 deg

Time to first fix (@ - 130 dBm):

- Hot start: 1s
- Cold start: <35 s

Modem support additional commands to control GPS/Glonass receiver for example to send and receive position frames, change port configuration, disabling/enabling frames output etc. For detailed informations please refer to AT commands reference guide.

15. RB900MODBUS

RB900MODBUS is a fully functional GSM/GPRS modem (please refer to RB900 specification) with additional hardware and a programmable module.

Beside the RB900 hardware it has a built-in RS485 module next to the RS232 module (available using one at a time).

RB900MODBUS can be controlled similarly to RB900, using AT commands and Python scripts, as well as by a MODBUS application written in C, which is prepared individually after contacting our R&D department. Previously developed applications were based on reporting values of the selected MODBUS registers to an HTTP server, communication with Clouds and controlling SCADA systems via SMS and TCP/IP connection. Please contact us about more details and possible solutions.

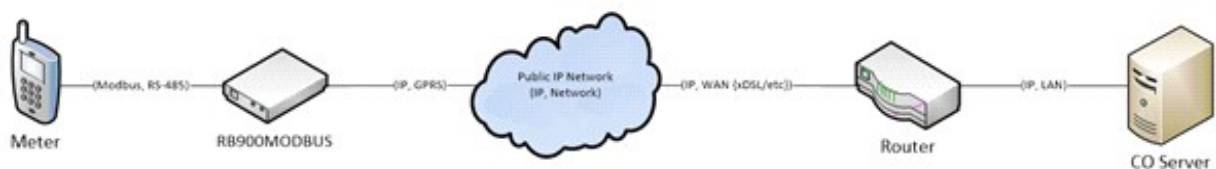

Typical RB900MODBUS application

We also provide a built-in demonstration application for RB900MODBUS. The device works in MODBUS RTU slave mode and reports alarms in the devices by sending SMS' to multiple numbers. The content of the messages and the alarm numbers are fully configurable. The alarms are triggered using either MODBUS function 6 (Write Single Register) or MODBUS function 16 (Write Multiple Registers). Please contact us for more details.

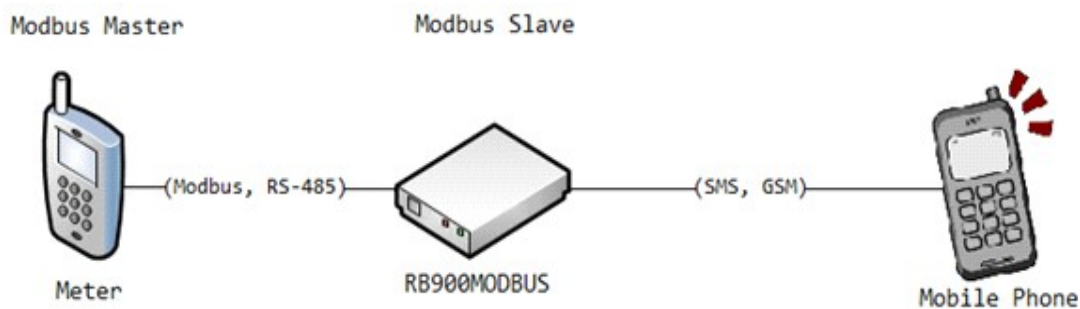

Test application schematic

16. AT Reference manual

Important: the following table list of AT commands is **available only for Python scripts to communicate with microcontroller through SER2 interface.**

COMMAND	Function
AT	Starting a Command Line
E	Command Echo
#VER	Device Version
#SLEEP	Switch device into power-down mode
#SD	SD card status
#SDRBLOCK	Read data block from SD card
#SDWBLOCK	Write data block to SD card

16.1. Command Echo - E

E - Command Echo	
ATE<n>	Set command enables/disables the command echo. Parameter: <n> 0 - disables command echo 1 - enables command echo (default) , hence command sent to the device are echoed back to the DTE before the response is given.
ATE?	Read command current state in format: <n> where <n> - as seen before

16.2. Device Version - #VER

#VER – Device Version	
AT#VER	<p>Read software and hardware version in format:</p> <p>AT#VER=<swver><hwver></p> <p>where</p> <p><swver> - version of microcontroller software</p> <p><hwver> - version of hardware</p>

16.3. Power-down mode - #SLEEP

#SLEEP – Power-down mode	
AT#SLEEP=<n>	<p>Set power-down mode.</p> <p>Parameter:</p> <p><n></p> <p>0 - active mode</p> <p>1 - deep power-down mode, GL865 is turn off. Automatically switch into active mode when external power connected.</p> <p>2 - deep power-down mode after 30 seconds, GL865 is turn off. Automatically switch into active mode when external power connected.</p> <p>NOTE: from version 2014061301</p>
AT#SLEEP?	<p>Read current power mode state in format:</p> <p>#SLEEP: <n></p> <p>where:</p> <p><n> - as seen before</p>

16.4. SD card status - #SD

#SD – SD card status	
AT#SD=<n>	<p>Reset and initialize sd card.</p> <p>Parameter:</p> <p><n></p> <p>1 - reset and initialize sd card.</p>

#SDRBLOCK – Read data block from memory card	
	<p>0123456789abcd_f0123456789abcdef0123456789abcdef0123456789abc def0123456789abcdef0123456789abcdef0123456789abcdef0123456789 abcdef0123456789abcdef0123456789abcdef0123456789abcdef0123456 789abcdef0123456789abcdef0123456789abcdef0123456789abcdef0123 456789abcdef0123456789abcdez OK</p>

16.6. SDWBLOCK write data block to memory card - #SDWBLOCK

#SDWBLOCK – Write data block to memory card	
AT#SDWBLOCK= <sector>	<p>Write one sector (512 bytes) to memory card</p> <p>Parameter: <sector> - sector address to write, ascii hexadecimal format (max 8 characters)</p> <p>The microcontroler shall prompt a five character sequence: >>> <CR><LF><greater_than><greater_than><greater_than></p> <p>after that 512 bytes can be send to microcontroler, in binary format.</p> <p>The operations completes when all the bytes are received. If writing ends successfully, the response is OK; otherwise an error is reported.</p>
Example	<p><i>Write to 6836th sector of memory card:</i></p> <p>AT#SDWBLOCK=1AB3</p> <p><i>>>> here receive the prompt; then send 512 bytes</i></p> <p>OK</p>

17. Safety recommendations

17.1 General Safety

Please follow safety regulations regarding the use of radio equipment due to the possibility of radio frequency interference. Read given advices carefully.

Switch **off** GSM terminal when:

- in an aircraft – using cellular telephones in aircraft may endanger the operation of the aircraft; it is illegal
- at a refuelling point
- in any area with potentially explosive atmosphere which could cause an explosion or fire
- in hospitals and any other places where medical equipment is in use

Respect restrictions on the use of radio equipment in any area or place where it is signalized that using cellular telephony is forbidden or dangerous.

Using GSM modem close to other electronic equipment may also cause interference if the equipment is inadequately protected. It may lead to damage or failure of GSM modem or the other equipment.

17.2 Care and Maintenance

The RB900 terminal is an electronic product that should be treated with care. Please follow suggestions shown below due to using modem for many years.

- Do not expose RB900 to any extreme circumstances like high temperature or high humidity
- Do not keep modem in dirty and dust places
- Do not disassemble the RB900 modem
- Do not expose the modem to any water, rain or steam
- Do not drop, shake or knocking your modem
- Do not place your modem close to magnetic devices – credit cards, etc
- Use of third party equipment or accessories, not made or authorized by Elproma Electronics may invalidate the warranty of modem and/or cause failure or permanent damage of modem
- Do not expose the modem to children under 3 years

17.3 Responsibility

The modem is under your responsibility. Please treat it with care, and respect local regulations. This is not a toy – keep it out of the reach of children.

Try to use security features (PIN etc.) to block unauthorized use or theft.

18. Accessories

The tables below shows recommended accessories for RB900 terminal.

18.1 Accessories critical for using modem

Table below shows accessories critical for using modem. Without them usage of modem is impossible.

Accessory	Description	Part no.
Power adaptor	6 V	

Example of power adaptor is shown in the picture below



Power adaptor 6V

18.2 Additional accessories

Table below shows available accessories for RB900 modem series.

Part No.	Name	Description
RB-PS12VP2L15	12V power adaptor	<1,5m> 2 PIN
RB-PSCP2L15	Supply cable	2PIN <1,5m> open end
RB-903G	3G angle antenna	2J010
RB-89MSH	SIM drawer	MOLEX 0912360001
RB-89DH	DIN Holder	
RB-89WMK	Wall mount kit	
RB-89R2L18	RS232 cable	DB9 male <1,8m> DB9 female
RB-902G	2G angle antenna	
RB-89R2L10IOL3	RS232+GPIO cable	rs232=1m DB9F, IO=0,3m open end

19. Conformity Assessment Issues

The RB900 has been assessed in order to satisfy the essential requirements of the R&TTE Directive 1999/05/EC (Radio Equipment & Telecommunications Terminal Equipments) to demonstrate the conformity against the harmonised standards with the final involvement of a Notified Body.



20. Safety Recommendations

READ CAREFULLY

Be sure the use of this product is allowed in the country and in the environment required. The use of this product may be dangerous and has to be avoided in the following areas:

- Where it can interfere with other electronic devices in environments such as hospitals, airports, aircrafts, etc
- Where there is risk of explosion such as gasoline stations, oil refineries, etc

It is responsibility of the user to enforce the country regulation and the specific environment regulation.

Do not disassemble the product; any mark of tampering will compromise the warranty validity.

We recommend following the instructions of the hardware user guides for a correct wiring of the product. The product has to be supplied with a stabilized voltage source and the wiring has to be conforming to the security and fire prevention regulations.

The product has to be handled with care, avoiding any contact with the pins because electrostatic discharges may damage the product itself. The same cautions have to be taken for the SIM, checking carefully the instruction for its use. Do not insert or remove the SIM when the product is in power saving mode.

The system integrator is responsible of the functioning of the final product; therefore, care has to be taken to the external components of the module, as well as of any project or installation issue, because the risk of disturbing the GSM network or external devices or having impact on the security. Should there be any doubt, please refer to the technical documentation and the regulations in force.

Every module has to be equipped with a proper antenna with specific characteristics. The antenna has to be installed with care in order to avoid any interference with other electronic devices and has to guarantee a minimum distance from the people (20 cm). In case of this requirement cannot be satisfied, the system integrator has to assess the final product against the SAR regulation.

1. The unit does not provide protection from lightning and surge. For outdoor installation use outdoor nonmetallic case safety approved according UL 50. Additionally you should provide protection from lightning and over voltage according National code.

2. Be sure the use of this product is allowed in the country and in the environment required. The use of this product may be dangerous and has to be avoided in the following areas: Where it can interfere with other electronic devices in environments such as hospitals, airports, aircrafts, etc. Where there is risk of explosion such as gasoline stations, oil refineries, etc. It is responsibility of the user to enforce the country regulation and the specific environment regulation. Do not disassemble the product; any mark of tampering will compromise the warranty validity. We recommend following the instructions of the hardware user guides for a correct wiring of the product. The product has to be supplied with a stabilized voltage source and the wiring has to be conforming to the security and fire prevention regulations. The product has to be handled with care, avoiding any contact with the pins because electrostatic discharges may damage the product itself. Same cautions have to be taken for the SIM, checking carefully the instruction for its use. Do not insert or

remove the SIM when the product is in power saving mode. The system integrator is responsible of the functioning of the final product; therefore, care has to be given to the external components of the unit, as well as of any project or installation issue, because the risk of disturbing the GSM network or external devices or having impact on the security. Should there be any doubt, please refer to the technical documentation and the regulations in force. Every unit has to be equipped with a proper antenna with specific characteristics. The antenna has to be installed with care in order to avoid any interference with other electronic devices and has to guarantee a minimum distance from the body (20 cm/8"). In case this requirement cannot be satisfied, the system integrator should assess the final product against the SAR regulation. The European Community provides some Directives for the electronic equipment introduced on the market. All the relevant information available on the European Community website:

<http://europa.eu.int/comm/enterprise/rte/dir99-5.htm>

The text of the Directive 99/05 regarding telecommunication equipment is available, while the applicable Directives (Low Voltage and EMC) are available at:

http://europa.eu.int/comm/enterprise/electr_equipment/index_en.htm

21. Certifications

Name: Industrial GSM/GPRS mdoem

Model: RB900

Reference standard(s):

RF spectrum use (R&TTE art. 3.2)

EN 301 511 V9.02

EMC (R&TTE art. 3.1b)

EN 301 489-1 V1.9.2

EN 301 489-7 V1.3.1

Health & Safety (R&TTE art. 3.1a)

EN 60950-1

Name: Industrial GSM/HSPA+ mdoem

Model: RB900U

Reference standard(s):

R&TTE 1999/5/EC

RF spectrum use (R&TTE art. 3.2)

EN 301 511 V9.02

EN 301 908-1 V5.2.1

EN 301 908-2 V5.2.1

EMC (R&TTE art. 3.1b)

EN 301 489-1 V1.9.2

EN 301 489-7 V1.3.1

EN 301 489-24 V1.5.1

EN 55022

Health & Safety (R&TTE art. 3.1a)

EN 60950-1

Name: Industrial GSM/LTE mdoem
Model: RB900L

Reference standard(s):

R&TTE 1999/5/EC
RF spectrum use (R&TTE art. 3.2)
EEN300 440-2 V1.4.1 N 301 511 V9.02
EN 301 908-1 V6.2.1 EN 301 908-2 V5.4.1
EN 301 908-2 V5.2.1

EMC (R&TTE art. 3.1b)
EN 301 489-1 V1.9.2 EN 301 489-3 V1.6.1
EN 301 489-7 V1.3.1 EN 301 489-24 V1.5.1
EN 55022 Class B

Health & Safety (R&TTE art. 3.1a)
EN 60950-1

22. List of Acronyms

ACM	Accumulated Call Meter
ASCII	American Standard Code for Information Interchange
AT	Attention commands
CB	Cell Broadcast
CBS	Cell Broadcasting Service
CCM	Call Control Meter
CLIP	Calling Line Identification Presentation
CLIR	Calling Line Identification Restriction
CMOS	Complementary Metal-Oxide Semiconductor
CR	Carriage Return
CSD	Circuit Switched Data
CTS	Clear To Send
DAI	Digital Audio Interface
DCD	Data Carrier Detected
DCE	Data Communications Equipment
DRX	Data Receive
DSR	Data Set Ready
DTA	Data Terminal Adaptor
DTE	Data Terminal Equipment
DTMF	Dual Tone Multi Frequency
DTR	Data Terminal Ready
EMC	Electromagnetic Compatibility
ETSI	European Telecommunications Equipment Institute
FTA	Full Type Approval (ETSI)
GPRS	General Radio Packet Service
GSM	Global System for Mobile communication
HF	Hands Free
IMEI	International Mobile Equipment Identity
IMSI	International Mobile Subscriber Identity
IRA	Internationale Reference Alphabet
ITU	International Telecommunications Union
IWF	Inter-Working Function
LCD	Liquid Crystal Display

LED	Light Emitting Diode
LF	Linefeed
ME	Mobile Equipment
MMI	Man Machine Interface
MO	Mobile Originated
MS	Mobile Station
MT	Mobile Terminated
OEM	Other Equipment Manufacturer
PB	Phone Book
PDU	Protocol Data Unit
PH	Packet Handler
PIN	Personal Identity Number
PLMN	Public Land Mobile Network
PUCT	Price per Unit Currency Table
PUK	PIN Unblocking Code
RACH	Random Access Channel
RLP	Radio Link Protocol
RMS	Root Mean Square
RTS	Ready To Send
RI	Ring Indicator
SAR	Specific Absorption Rate (e.g. of the body of a person in an electromagnetic field)
SCA	Service Center Address
SIM	Subscriber Identity Module
SMD	Surface Mounted Device
SMS	Short Message Service
SMSC	Short Message Service Center
SPI	Serial Protocol Interface
SS	Supplementary Service
TIA	Telecommunications Industry Association
UDUB	User Determined User Busy
USSD	Unstructured Supplementary Service Data

23. Online support

Elproma provides a range of online support which includes:

- the latest version of this document
- the latest drivers for RB900
- technical support

This information can be found on our web sites at www.teleorigin.com

For further information you can contact us at:

email: info@elpromaelectronics.com

tel.: **+48 (22) 751 76 80**

fax.: +48 (22) 751 76 81

skype: [elproma.elektronika](https://www.skype.com/add?contact=elproma.elektronika)

TELEORIGIN
UNIQUE TECHNOLOGY FOR TELEMETRY

THANK YOU