

RBMTX-Lite

USER MANUAL



GSM/UMTS/LTE



Index

1 Document history.....	5
2 Package.....	6
2.1 Box.....	6
2.2 Package contents.....	6
2.3 Router versions.....	7
3 General presentation.....	8
3.1 Front panel.....	8
3.2 Back panel.....	8
3.3 External connections.....	9
3.3.1 GSM/UMTS/LTE antenna connector.....	9
3.3.1 WiFi + Bluetooth or GNSS antenna connector.....	9
3.3.2 Router serial port, either full RS232/RS485.....	10
3.3.3 LAN connector.....	10
3.3.4 Power supply connector.....	11
3.3.5 SIM card holders.....	12
3.4 Product sticker.....	12
3.5 LED operation.....	13
4 Basic features and services.....	14
5 Using the router.....	15
5.1 Setting up the router.....	15
5.1.1 Inserting SIM card(s).....	15
5.1.2 Connecting antenna.....	16
5.1.3 Connecting power supply cable.....	17
5.1.4 Connecting LAN cable with RJ-45.....	17
5.2 Router configuration.....	18
5.2.1 Setting up the connection.....	18
5.2.2 Router status page.....	19
5.2.3 WAN config.....	21
5.2.4 Local network.....	22
5.2.5 Router settings.....	23
5.2.6 Connection control.....	24

5.2.7 Ports configuration.....	25
5.2.8 TCP/IP forwarding.....	26
5.2.9 VLAN.....	27
5.2.10 Static routes.....	28
5.2.11 Dynamic DNS.....	29
5.2.12 Access control.....	30
5.2.13 Open VPN.....	32
5.2.14 Ipvsec static/Ipvsec mobile.....	34
5.2.15 Generating SSL certificates.....	37
5.2.16 NTRIP configuration page.....	39
5.2.17 Text messages actions.....	40
5.2.18 E-mail actions.....	41
5.2.19 SNMP.....	42
5.2.20 Time.....	43
5.2.21 Syslog.....	44
5.2.22 User files.....	45
5.2.23 Backup and restore.....	46
5.2.24 Discard changes.....	46
5.2.25 Save settings	46
5.3 System logs description.....	47
5.4 Elproma Device Manager.....	48
6 Troubleshooting.....	50
6.1 No communication with the router.....	50
6.2 Router answers but there is no internet connection.....	50
7 Technical characteristics.....	51
7.1 Mechanical characteristic.....	51
7.2 Housing (dimension diagram).....	51
7.3 Electrical characteristic.....	51
7.3.1 Power supply.....	51
7.3.2 RF characteristics.....	52
7.3.2.1 Frequency ranges – UMTS/HSPA variant.....	52
7.3.2.2 Frequency ranges - LTE variant.....	53
7.3.2.3 WiFi characteristics.....	54

7.3.2.4 External antenna.....	54
7.4 Environmental characteristic.....	55
8 Router architecture.....	56
9 Safety recommendations.....	57
9.1 General Safety.....	57
9.2 Care and Maintenance	57
9.3 Responsibility	57
10 Accessories.....	58
Power cable – open end.....	58
RS232/485 cable.....	58
11 Safety Recommendations.....	59
12 Certifications.....	61
12.1 Conformity Assessment Issues.....	61
12.2 Declararions of conformity.....	61
12.3 National restrictions.....	61
13 List of Acronyms.....	62
14 On-line support.....	64

1 Document history

Revision	Date	Changes
#0.6	8.03.2018	- Preliminary version
#0.8	21.05.2018	- New screenshots
#0.9	13.09.2018	- LED description
#1.0	18.01.2018	- New router variants, corrected screenshots
#1.1	17.04.2019	- OpenVPN certificates generation
#1.2	21.01.2020	- GNSS + Wi-Fi/Bluetooth description

2 Package

2.1 Box

User can find product sticker on the box which matches sticker placed on the device - it proves that your router is an original product. More information about stickers are in chapter Product sticker

2.2 Package contents



Complete package contains:

1. RBMTX-Lite router
2. Antenna GSM (SMA connector)
3. Power adapter
4. Wall holder

2.3 Router versions

There are many ways to upgrade your RBMTX-Lite router. List below shows typical configuration and different combinations (variants) of this router.

Option	Typical	Option
Power supply	9-30V	-
Memory	256MB RAM, 512MB MicroSD card (part used for Linux system, the size of SD card can be changed in the future)	-
Processor	Cortex A7, max. 528MHz, I.MX6UL(L)	-
RS232	System console	-
RS485	1	-
Connection	UMTS/LTE Cat. 1	LTE Cat. 4
Dual SIM	available	-
LAN	Ethernet 10/100Mbps	-
Wi-Fi + Bluetooth	-	available
GNSS receiver	-	available (variant without WiFi+Bluetooth)

3 General presentation

3.1 Front panel

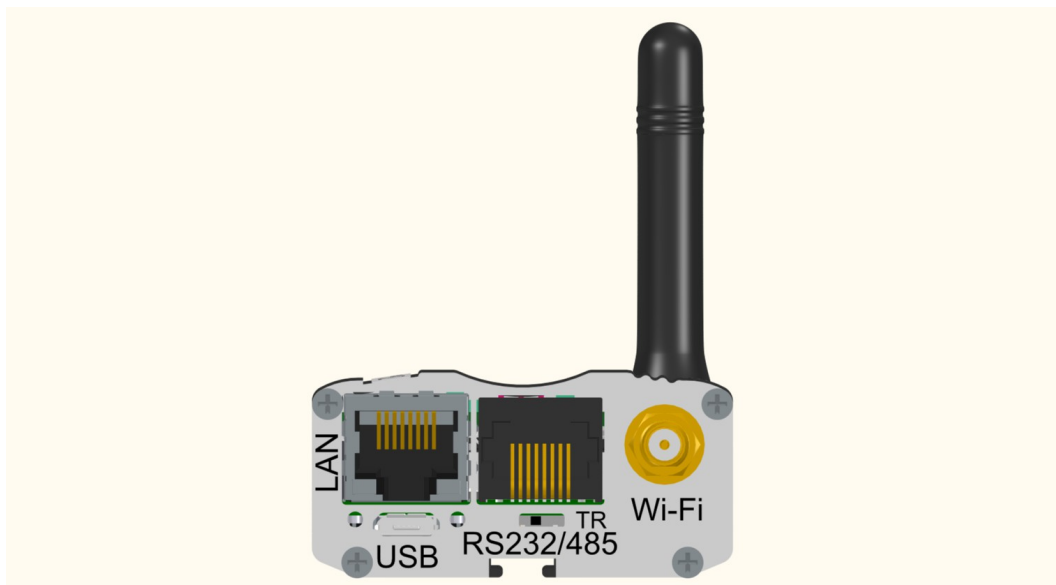

3.2 Back panel

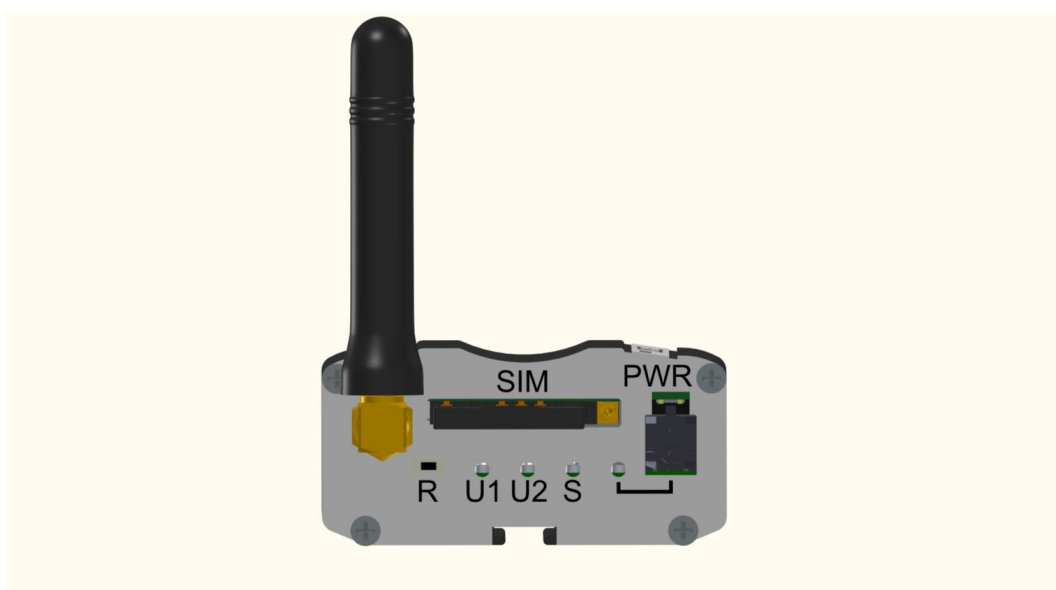

3.3 External connections

3.3.1 GSM/UMTS/LTE antenna connector

SMA antenna connector placed on front panel is used to connect external GSM/UMTS/LTE. It must be connected to establish a connection with GSM/UMTS/LTE network. In good circumstances (good coverage, level of received signal is high) use antenna which is included in package. When signal strength is poor please use outdoor directional/omnidirectional or indoor antenna.

Note: *If antenna is not connected, connection with GSM/UMTS/LTE network will be impossible.*

Note: *Make sure you don't tighten the antenna too much. The torque setting of SMA connector is 0.15 – 0.20 NM.*

3.3.1 WiFi + Bluetooth and GNSS antenna connector

Router can be optionally equipped with WiFi+Bluetooth or GNSS receiver (select the appropriate router variant when ordering). SMA antenna connector placed on back panel is used to connect external WiFi+Bluetooth or GNSS antenna. WiFi+Bluetooth antenna connector type is SMA male, but GNSS antenna connector type is female (the same as for GSM/UMTS/LTE antenna).

Note: *If antenna is not connected, connection with WiFi/Bluetooth network/GNSS system will be impossible. To let the router get the correct position (NMEA coordinates) put the antenna outside (in a place where the GNSS system is visible).*

Note: *Make sure you don't tighten the antenna too much. The torque setting of SMA connector is 0.15 – 0.20 NM.*

3.3.2 Router serial port, either full RS232/RS485

Serial RS232/RS485 (RJ-45 connector marked as “RS232/485”) is placed on front panel of router. Serial connector pinout is described in a tables below.

version		
RS232 RS485	2x RS485	RB-MTX
		RJ45
A	A1	1
5V	5V	2
B	B1	3
GND	GND	4
TX	A2	5
RX	B2	6
RTS	NC	7
CTS	NC	8

	Rb-MTX	RS232	RS485
	RJ45	DB9F	DB9F
A	1	nc	1
5V	2	2	2
B	3	3	nc
GND	4	nc	nc
TX	5	5	5
RX	6	ns	6
RTS	7	7	nc
CTS	8	8	nc

3.3.3 LAN connector

Second RJ-45 connector (marked as “LAN”) is placed next to serial connector and is used for communication with PC or laptop through Ethernet interface. WWW configuration is available in the web browser (default IP address is 192.168.1.234). You can change the default address in [“Local network”](#) tab.

3.3.4 Power supply connector

Please use power adapter which is included in package. It ensures “clean” power supply input and avoids short transients on power supply lines originating from inductive load switching. Power supply range of RBMTX-Lite router is 9-30V.

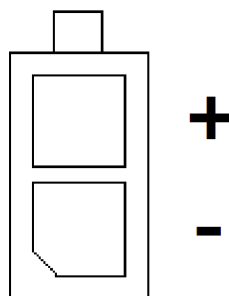
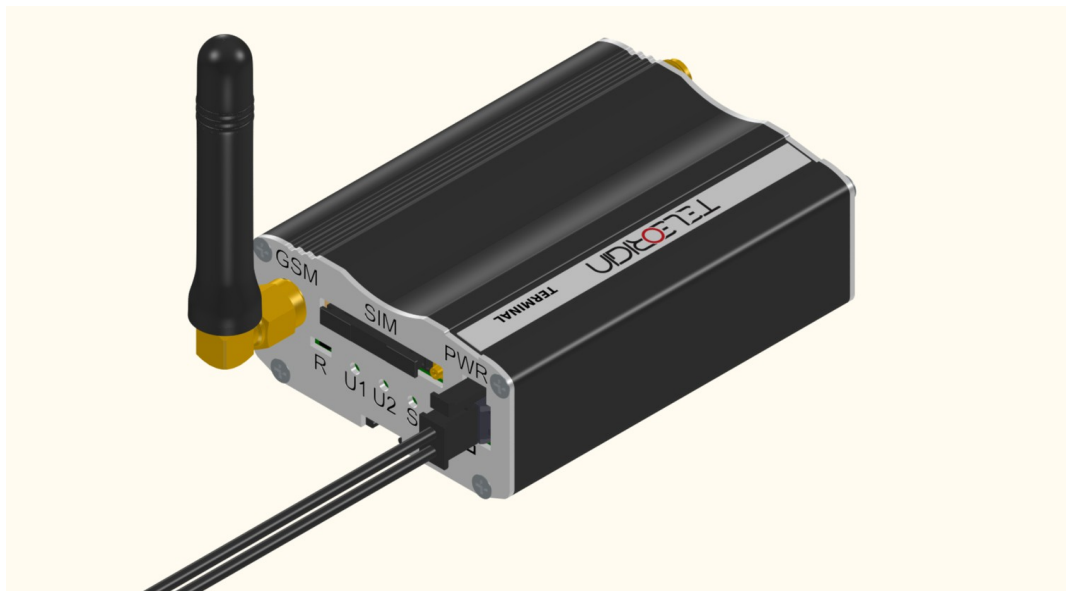

Power supply connector pinout

NOTE: The device is switched off by removing the external power supply from the electric socket. The electric socket must be located close to the device and easily accessible.

3.3.5 SIM card holders



One SIM card holder is placed in front panel of RBMTX-Lite and the second one is located inside the device. To insert SIM card into the extractable holder **push yellow button and take SIM drawer out** as show in the picture and place SIM card. To operate the module in a GSM network, it is necessary to insert at least one active SIM card.

3.4 Product sticker

A production sticker includes the following information:

- Product serial number
- CE marking
- 15-digit bar code
- model signature (RBMTX-Lite)

3.5 LED operation

Router has four LED indicating its operation. The diode description is presented in the table below.

Diode	Color	Description
U1	Red	User controlled
U2	Blue	Router activity
S	Yellow	Network indicator: RBMTX-Lite 3G: <ul style="list-style-type: none">• Flicker slowly (200ms ON, 1800ms OFF) – Network searching• Flicker slowly (1800ms ON, 200ms OFF) – Idle/Data transfer• Always ON – Voice/CSD calling RBMTX-Lite 4G: <ul style="list-style-type: none">• Flicker slowly (200ms ON, 1800ms OFF) – Network searching• Flicker slowly (1800ms ON, 200ms OFF) – Idle• Flicker quickly (125ms ON, 125ms OFF) – Data transfer• Always ON – Voice calling
PWR	Green	Power supply

4 Basic features and services

Basic features and available services are contained in table below.

Feature / service	Description
Supported bands	UMTS/HSPA variant: <ul style="list-style-type: none"> GSM 900/1800 MHz UMTS 900/2100 MHz LTE variant: <ul style="list-style-type: none"> GSM 900/1800 MHz WCDMA FDD B1, B8 Class 3 LTE FDD B1, B3, B7, B8, B20 Cat. 1 and Cat. 4
Data features	<ul style="list-style-type: none"> LTE Cat. 1 (downlink 10 Mbit/s, uplink 5 Mbit/s) LTE Cat. 4 (downlink 150 Mbit/s, uplink 50 Mbit/s) UMTS(downlink 7.2 Mbit/s) GPRS (Multi-slot class 10, max BR downlink 85,6 Kb/s) Embedded protocols: PPP, TCP/IP, UDP/IP, MMS, HTTP, HTTPS, SSL, FTP, FTPS, SMTP, SMTPS, NTP, NITZ, PING Ports forwarding, Isec, OpenVPN Class B GSM 07.10 multiplexing protocol
WiFi*	Standard: <ul style="list-style-type: none"> 802.11b/g/n Data rate: <ul style="list-style-type: none"> up to 150 Mbps
Bluetooth*	V4.1+EDR
Power supply	<ul style="list-style-type: none"> Nominal voltage range: 9V-30V Maximum continuous (average) supply power: 5W Peak (momentary) supply current: 1 A
Interfaces (typical version)	<ul style="list-style-type: none"> GSM/UMTS/LTE antenna connector: SMA 2 x SIM Card (second SIM is internal): 1.8V, 3V standards RS232 and RS485 via RJ-45 RJ-45 connector (x2) microUSB (OTG) Power supply connector Factory default reset button 4 x LED
Options*	<ul style="list-style-type: none"> WiFi and Bluetooth antenna connector: SMA male GNSS antenna connector: SMA female
Other	Physical size: <ul style="list-style-type: none"> Max. Dimensions: 83 x 53.5 x 26 mm (w/ connectors) Operating temperature range: <ul style="list-style-type: none"> Min. -20°C Max. 60°C

*option

5 Using the router

5.1 Setting up the router

To set the router, do the following steps:

5.1.1 Inserting SIM card(s)

- Push yellow button placed on front panel and take SIM drawer out.
- Place SIM card in the holder as shown in the picture:



Router is available with one or two SIM card slots. To insert the second SIM card please unscrew one of the routers panel, eject PCB board and put the SIM into internal SIM holder.

5.1.2 Connecting antenna

- Connect GSM/UMTS/LTE antenna to SMA connector



5.1.3 Connecting power supply cable

- Connect power supply cable into power supply connector



5.1.4 Connecting LAN cable with RJ-45

- Plug LAN cable into RJ-45 plug.

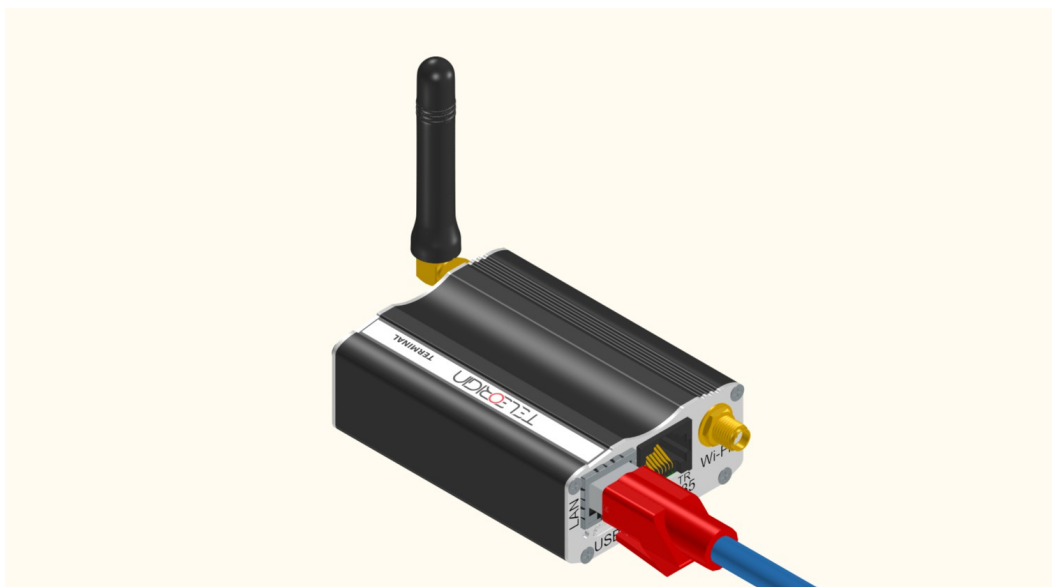

5.2 Router configuration

Router is configured via web browser. Router settings are divided into sections which allows user to easily find needed option. If you need to save new settings please apply them using "Save settings". You can also discard changes by choosing appropriate option from menu.

WARNING: Cache of router is cleared on device reset.

NOTE: Not all tabs are available on every router version.

5.2.1 Setting up the connection

When you connect all necessary cables (see Setting up the r) you can setup connection. Connect LAN cable to your computer and go to Internet protocol TCP/IP properties (**Network connections -> Local Area Connection ->Internet protocol TCP/IP-> Properties**) and set your IP address as 192.168.1.x. Please read how to change TCP/IP settings of your network card in this thread (example for Windows 7):

<http://windows.microsoft.com/en-us/windows/change-tcp-ip-settings#1TC=windows-7>

5.2.2 Router status page

Go to your web browser and put IP address **192.168.1.234**. You will be asked for username and password. By default it is:

Username: **admin**

Password: **12345**

If everything is configured correctly you should see following screen:



RBMTX3 Router Configuration



Modem EG91, 1 SIM, firmware: 181128

www.teleorigin.com

Device status

Basic

- Wan config
- Local network
- Modem settings
- Connection control
- Ports configuration
- TCP/IP forwarding
- VLAN
- Static routes
- Dynamic DNS
- Access control

Advanced

- OpenVPN
- IPsec
- IPsec authentication
- NTRIP
- Text messages actions
- E-mail actions
- SNMP

Administration

- Registration
- Time
- Syslog
- User files

Configuration

- Backup and restore
- Discard changes

Save Settings

Status

System	CPU load	0.10, 0.10, 0.13, 1/91, 17683
	Temperature	51.2°C
	Up time	5d 6:7:50
	Memory (total/free)	253040 kB/186356 kB
Modem information	Model, firm. ver., IMEI	EG91 (EG91EFBR06A04M4G), IMEI: 862831030128867
	PIN, Operator	READY, Operator: Orange Orange
	Network Status	Registered (home network, LAC=E2EA, CID=2C32424)
	Signal Strength (CSQ)	Excellent, -67 dBm (CSQ=23)
	Packet Data Service	LTE
GSM Connected	GSM SIM selection	MASTER
	IP/Mask	10.66.27.61/255.255.255.252
	MAC Address	1E:8E:E5:A0:94:EC
LAN1	RX/TX bytes (packets)	26.58 MB/29.86 MB (119036/109278)
	IP/Mask	192.168.90.125/255.255.255.0
	MAC Address	36:07:11:44:44:1F
WiFi	RX/TX bytes (packets)	40.66 MB/4.66 KB (150874/204)
	SSID	AP4 (freq: 2.447 GHz)
	Link quality/Signal level	47/70/-63 dBm
	AP MAC	70:4D:78:D1:CB:A0
	IP/Mask	192.168.90.125/255.255.255.0
VPN CLOUD	MAC Address	A0:C9:A0:5B:07:A3
	RX/TX bytes (packets)	45.75 MB/27.52 MB (171762/51258)
	IP/Mask	172.63.5.15/255.255.255.0
	RX/TX bytes (packets)	16.50 MB/21.73 MB (75841/63385)

You can check if router is connected to network, its parameters and information about PPP connection. Device status page is refreshing automatically.

In table below you can find the description of each field in “Device status” tab:

Field	Example	Description
CPU Load	0.67, 0.22, 0.16, 1/85, 9732	CPU load parameters
Temperature	51,2 C	Processor temperature
Uptime	20d 19:22:21	Total uptime
Memory (total/free)	253040 kB/192532 kB	Total/free memory available
Model, firmware ver., IMEI	GMM: UG95 or EG9x	GSM module info
IMEI	359852050093104	device serial number
PIN, Operator	READY, Operator: Orange	Available SIM card statuses: SIM PIN - PIN lock (please set right PIN number in “GSM network” tab) READY - SIM unlocked SIM PUK - PUK lock
Network Status	Registered (home network, LAC=2B21, CID=028FC03)	registration status (1st parameter), location area code (2nd parameter), cell ID (3rd parameter). Possible statuses: - not registered, router is not currently searching a new operator to register to - registered, home network - not registered, but router is currently searching a new operator to register to - registration denied - unknown - registered, roaming
Signal Strength (CSQ)	Excellent, -73 dBm (CSQ=20)	-
Packet Data Service	LTE	type of packet data service
GSM selection	MASTER	SIM card selection
LAN1 IP/Mask	192.168.90.125/255.255.255.0	-
LAN1 MAC address	36:07:11:44:44:1F	-
RX/TX bytes (packets)	40.66 MB/4.66 KB (150885/204)	RX/TX packets used
VPN CLOUD IP/Mask	172.63.5.15/255.255.255.0	Routers with TACS option
VPN CLOUD RX/TX bytes (packets)	10.11 MB/7.05 MB (41778/29863)	

5.2.3 WAN config

WAN config page is shown in the illustration below.

The screenshot displays the 'WAN configuration' page for the RBMTX3 Router. The page is divided into a left sidebar and a main content area. The sidebar contains a navigation menu with categories: Device status, Basic, Advanced, Administration, and Configuration. The 'Basic' category is expanded, showing 'Wan config' as the selected option. The main content area is titled 'WAN configuration' and contains a section for 'WAN interface / default gateway configuration'. This section includes several configuration options:

- WAN interface:** A dropdown menu set to 'GSM'.
- NAT:** A section with three checkboxes: 'WAN' (checked), 'LAN1', and 'WIFI'. Below these is the text 'Network Address Translation on the interface'.
- Set default gateway manually:** A checkbox labeled 'Enabled' which is unchecked.
- Default gateway interface:** A dropdown menu set to 'GSM'.
- Default gateway IP address:** A text input field with the placeholder text 'Enter default gateway'.
- Set default DNS manually:** A checkbox labeled 'Enabled' which is unchecked.
- Nameserver IP master:** A text input field containing '8.8.8.8'.
- Nameserver IP slave:** A text input field containing '8.8.4.4'.

At the bottom of the sidebar, there is a red button labeled 'Save Settings'.

5.2.4 Local network

On “Local network” configuration page you can find essential parameters needed for LAN connection. Here you can set IP Address (or set it to be downloaded via DHCP), mask, default gateway and DNS addresses. Last two options can be entered manually or downloaded automatically via GSM or DHCP. Router can also works as DHCP server - you can define its range and set list of IP-MAC binds.

“Wireless configuration” field is available only in RBMTX-Lite with WiFi option. You can set there a parameters of your WiFi connection. To scan all available networks please use “Scanning” button. You will be redirected to page with list of networks in a view. You can set a WiFi mode (Access point or Station), fill a name and password of selected network. You can also enable DHCP server and AP clients.

The screenshot displays the RBMTX3 Router Configuration web interface. The top navigation bar includes the TELEORIGIN logo, the title 'RBMTX3 Router Configuration', and the ELPROMA logo. Below the navigation bar, the device information is shown: 'Modem EG91, 1 SIM, firmware: 181128' and the website 'www.teleorigin.com'.

The main content area is titled 'Networking' and is divided into two sections:

- LAN configuration:** This section contains several configuration rows:
 - IP configuration:** Configuration: Static, IP Address: 192.168.90.125, Mask: 255.255.255.0
 - DHCP Server:** Enabled (checkbox), Range Start: 192.168.1.100, Range End: 192.168.1.200
 - Defined DNS servers for DHCP clients:** Enabled (checkbox), Master: [empty], Slave: [empty]
 - MAC address:** Set (checkbox), Enter MAC Address: [empty]
- Wireless configuration:** This section includes:
 - Wifi scanner:** A red 'Scanning' button.
 - WiFi Network:** Mode: Station, Name (SSID): AP4, Hidden network: checked.
 - Network parameters:** Country: Select Country, Channel: 5, Security: WPA/WPA2-1, Password: [empty]
 - IP configuration:** Configuration: Static, IP Address: 192.168.90.125, Mask: 255.255.255.0
 - DHCP Server:** Enabled (checkbox checked), Range Start: 192.168.1.100, Range End: 192.168.1.200
 - DNS:** Enabled (checkbox), Master: [empty], Slave: [empty]

At the bottom of the wireless configuration section, there is a 'DHCP server: Bind MAC to IP' section with a 'Binds list' table containing a dropdown menu and 'New' and 'Delete' buttons. A note below reads: 'Please choose DHCP bind you would like to edit. Please note that after editina DHCP binds you have to save alabal'.

A 'Save Settings' button is located in the bottom left corner of the configuration area.

5.2.5 Router settings

On “Router settings” page you can define internet connection parameters (APN, username, password, CSD, ISP IP and Modem band) for one or two SIM cards (depending on router version). To use internet you should know those parameters - they are essential for getting access to internet. The parameters should be ensured by your mobile network provider.

The screenshot shows the RBMTX3 Router Configuration web interface. The top navigation bar includes the TELEORIGIN logo (UNIQUE TECHNOLOGY FOR TELEMTRY) on the left, 'RBMTX3 Router Configuration' in the center, and the ELPROMA logo and website URL 'www.teleorigin.com' on the right. Below the navigation bar, the modem information is displayed: 'Modem EG91, 1 SIM, firmware: 181128'. The main content area is titled 'Modem settings' and contains a table for 'GSM connection settings'.

GSM connection settings	
SIM slot	Master
PIN	<input checked="" type="checkbox"/> Enabled
	<input type="text" value="1234"/> <i>Enter PIN here</i>
Predefined APN	<input type="text" value="enter manually"/>
APN	<input type="text" value="internet"/> <i>Enter APN here or select it from above list</i>
Username	<input type="text"/> <i>Enter username here</i>
Password	<input type="text"/> <i>Enter password here</i>
Modem band	<input type="text" value="2G, 3G and 4G"/> <i>Select modem band</i>
Connection	<input type="text" value="Always on"/> <i>Modem connect</i>

A sidebar menu on the left lists various configuration options, with 'Modem settings' highlighted. At the bottom of the sidebar, there is a red 'Save Settings' button.

To enter the PIN for SIM card you need to mark “Enabled” field and then fill the field below with correct PIN. Please note that outgoing calls are made always on MASTER SIM card.

5.2.6 Connection control

Here you can set parameters of switching between two SIM cards. You can define time for ping and ping counter for 4 IP addresses you choose. In example (picture) here after 3 pings that take 10 seconds each card will change from Master to Slave or opposite.



UNIQUE TECHNOLOGY FOR TELEMETRY

RBMTX3 Router Configuration

Modem EG91, 1 SIM, firmware: 181128



www.teleorigin.com

Device status

Basic

Wan config

Local network

Modem settings

Connection control

Ports configuration

TCP/IP forwarding

VLAN

Static routes

Dynamic DNS

Access control

Advanced

OpenVPN

IPsec

IPsec authentication

NTRIP

Text messages actions

E-mail actions

SNMP

Administration

Registration

Time

Syslog

User files

Configuration

Backup and restore

Discard changes

Save Settings

GSM switching

GSM connection control

Limits	<input type="text" value="10"/> <small>Enter ping timeout in seconds (1-1000)</small>
	<input type="text" value="3"/> <small>Enter ping count (1-3600)</small>
	<input type="text" value="600"/> <small>Enter ping interval in seconds (0-86400, 0 - disable)</small>
	<input type="text" value="60"/> <small>Enter ping threshold in percent (1-100)</small>
IP 1	<input type="checkbox"/> Enabled <small>Set this option to enable ping testing IP 1</small> <input type="text"/> <small>Enter IP address</small>
IP 2	<input type="checkbox"/> Enabled <small>Set this option to enable ping testing IP 2</small> <input type="text"/> <small>Enter IP address</small>
IP 3	<input type="checkbox"/> Enabled <small>Set this option to enable ping testing IP 3</small> <input type="text"/> <small>Enter IP address</small>
IP 4	<input type="checkbox"/> Enabled <small>Set this option to enable ping testing IP 4</small> <input type="text"/> <small>Enter IP address</small>

5.2.7 Ports configuration

User is able to set port settings under RS232/RS485 port configuration page. There are 3 configurable ports: /dev/ttyS0, /dev/ttyACM0 and /dev/ttyS1 or /dev/ttyUSB0 (depending on router version). Every port can be set to different mode. On /dev/ttyS0 you can set router, ModBus gateway or NTRIP mode. Two other ports can work as modem port (modem control and modem data) or SMS receiving port (see also: SMS Actions section).

Every port can also be set to forwarding mode that allows user to forward it to TCP/UDP port (as server or client). Port /dev/ttyS0 can also be forwarded to modem control or modem data port. In that case no other mode can be set on that port. Setting modes on /dev/ttyS0 and /dev/ttyS1 (LTE router variant only) enables setting port parameters: baud rate, data bits, parity checking and protocol. If parameter is inactive, this means that user can't control it in currently set mode.

TELEORIGIN | RBMTX3 Router Configuration | ELPROMA

Modem EG91, 1 SIM, firmware: 181128 | www.teleorigin.com

Ports

Port type	Serial RS-232 External /dev/rs232	Serial RS-485 External /dev/rs485	Modem control Internal Port-A
Mode	None	None	None
Baud rate	115 200	115 200	
Data bits	8	8	
Parity	None	None	
Stop bits	1	1	
Flow control	None	None	
Forwarding configuration			
To	Network	Network	
Mode	Server	Server	Server
Interface	LAN	WAN	LAN
Protocol	TCP	TCP	TCP
Server IP or domain			
Server as domain name	<input type="checkbox"/> Enter Server as domain name		
Port			

Save Settings

5.2.8 TCP/IP forwarding

You can forward single port or port ranges onto certain IP address. To add new rule for single port, enter TCP/IP Forwarding tab. In "Single port rules" section click button "New" and enter all necessary informations: Identifier, check "Enabled" field, enter external and internal port, choose protocol (TCP or UDP) and enter IP address. When adding new rule or switching tab, currently edited rule is automatically saved. You can delete it (or any other rule) by pressing "Delete" button. After changes click Save Settings to save whole configuration. You can edit port range rules in the same way in Port range rules section. You can also set IP address of demilitarized zone in DMZ section.

TELEORIGIN | RBMTX3 Router Configuration | ELPROMA

Modem EG91, 1 SIM, firmware: 181128 | www.teleorigin.com

TCP/IP forwarding

Single port rules

Rules list: [Dropdown]

[New] [Delete]

Please choose a rule you would like to edit. Please note that after editing rules you have to save global settings.

Identifier: [Text Field]
Please enter any name/identifier

Enable rule: Enabled
Set this option to enable this rule

External port: [Text Field]

Internal port: [Text Field]

Protocol: [Dropdown]

IP address: [Text Field]

Port range rules

Rules list: [Dropdown]

[New] [Delete]

Please choose a rule you would like to edit. Please note that after editing rules you have to save global settings.

Identifier: [Text Field]
Please enter any name/identifier

Enable rule: Enabled
Set this option to enable this rule

First port: [Text Field]

Last port: [Text Field]

Protocol: [Dropdown]

[Save Settings]

5.2.9 VLAN

VLAN tab enables user to create virtual IP addresses. You can define IP, netmask and identifier from range 0-4095. If you enable IEEE 802.1Q tagging Virtual IP becomes part of VLAN.

The screenshot displays the RBMTX3 Router Configuration interface. The top header includes the TELEORIGIN logo, the text 'RBMTX3 Router Configuration', the ELPROMA logo, and the website 'www.teleorigin.com'. Below the header, it shows 'Modem EG91, 1 SIM, firmware: 181128'. The left sidebar contains a navigation menu with categories: Device status, Basic, Advanced, Administration, and Configuration. The 'VLAN' option under the 'Basic' category is highlighted in red. The main content area is titled 'VLAN/Virtual IP configuration' and contains the following fields and controls:

- VLAN Virtual IP list:** A dropdown menu with a 'New' button and a 'Delete' button. Below it is a note: 'Please choose VLAN you would like to edit. Please note that after editing those things you have to save global settings.'
- Enable VLAN:** A checkbox labeled 'Enabled' with the instruction 'Set this option to enable this VLAN'.
- Description:** A text input field with the instruction 'Please enter VLAN description.'
- Interface:** A dropdown menu showing 'LAN1'.
- IEEE 802.1Q tagging:** A checkbox labeled 'Enabled' with the instruction 'Set this option to enable IEEE 802.1Q tagging'.
- Identifier:** A text input field with the instruction 'Please enter number from range 0-4095.'
- IP:** A text input field.
- Netmask:** A text input field.

A 'Save Settings' button is located at the bottom of the sidebar.

5.2.10 Static routes

Under static routes tab you can define your own routings. Please click Add new button to add new routing. Enter identifier (used only to distinguish routings in www configuration), choose interface, enter destination network, netmask and gateway.

The screenshot shows the RBMTX3 Router Configuration web interface. The top header includes the TELEORIGIN logo, the title 'RBMTX3 Router Configuration', the ELPROMA logo, and the website 'www.teleorigin.com'. Below the header, the modem information 'Modem EG91, 1 SIM, firmware: 181128' is displayed. The left sidebar contains a navigation menu with categories: Device status, Basic (Wan config, Local network, Modem settings, Connection control, Ports configuration, TCP/IP forwarding, VLAN, Static routes, Dynamic DNS, Access control), Advanced (OpenVPN, IPsec, IPsec authentication, NTRIP, Text messages actions, E-mail actions, SNMP), Administration (Registration, Time, Syslog, User files), and Configuration (Backup and restore, Discard changes). A 'Save Settings' button is located at the bottom of the sidebar. The main content area is titled 'Static routes' and features a 'Static routes list' table with a dropdown menu. Below the table are 'New' and 'Delete' buttons, followed by a note: 'Please choose a route you would like to edit. Please note that after editing routes you have to save global settings.' The form fields include: Identifier (with a note 'Please enter any name/identifier/IP'), Destination network, Destination netmask, Interface (set to 'None'), and Gateway.

5.2.11 Dynamic DNS

Dynamic DNS is a service which allows user to make your device available under specific www address regardless of its IP changes. In order to do that you must create an account on one of web pages that are supported by RBMTX-Lite router (currently DynDNS.org or No-IP.com). After creating account, please enter necessary information in Dynamic DNS tab of www configuration: your service provider, in case of DynDNS its type, username, password, host name and two intervals. Update interval is time between two checks whether IP address had changed. Forced update interval is time between updating IP data regardless of IP change. Please last two fields empty to use default value if you're not sure what to input there.



RBMTX3 Router Configuration
Modem EG91, 1 SIM, firmware: 181128

www.teleorigin.com

- Device status
- Basic
 - Wan config
 - Local network
 - Modem settings
 - Connection control
 - Ports configuration
 - TCP/IP forwarding
 - VLAN
 - Static routes
 - Dynamic DNS
 - Access control
- Advanced
 - OpenVPN
 - IPsec
 - IPsec authentication
 - NTRIP
 - Text messages actions
 - E-mail actions
 - SNMP
- Administration
 - Registration
 - Time
 - Syslog
 - User files
- Configuration
 - Backup and restore
 - Discard changes

Save Settings

Dynamic DNS

DDNS service	<input type="text" value="Disabled"/> <small>Note that DDNS can only work on devices with public IP.</small>
DynDNS type	<input type="text" value="Custom"/>
Username	<input type="text"/> <small>Enter username</small>
Password	<input type="text"/> <small>Enter password</small>
Hostname	<input type="text"/> <small>Enter hostname</small>
Update interval (sec)	<input type="text"/> <small>IP change check interval. Default: 1 min. Max: 10 days Leave this field empty to use default value</small>
Force update interval (sec)	<input type="text"/> <small>Forced DDNS server update interval. Default: 1 week Leave this field empty to use default value</small>

5.2.12 Access control

First section of Access Control tab allows you to configure SSH protocol. You can turn it on or off, set on which port and interfaces (also OpenVPN and IPsec tunnels) it should be accessible. You can also toggle logging via SSH as root and change/delete passwords/keys for root and service user. Remember to save whole configuration after changing password by pressing Save Configuration button from main menu. Deleting password means that it won't be needed to log on. When logging via SSH, key authentication has higher priority than password. That means that user with authorized key won't be prompted for a password and user without key will be able to login using password. You can paste multiple keys into SSH root key and SSH service key fields.

ATTENTION: Service account is used to upgrade firmware. Turning SSH off will disable firmware upgrades.

You can generate necessary keys directly on router. Press the Generate button and wait for a while-the process can take few minutes. You should not change settings or switch tabs then. After the generation the message will be displayed. Public key will be automatically pasted into the keys field (if the field wasn't empty before pressing the button, its contents will be saved, the newly generated key will appear first on the list). From now you will be able to download private and public keys by pressing Get private key and Get public key buttons. To login using the key under Linux, you have to download private key, change its name to id_rsa and put it in /home/user/.ssh folder.

In WWW config access section you can toggle HTTP/HTTPS access www configuration and change ports and interfaces (OpenVPN and IPsec tunnels also) on which they will be available. You can also change password for www configuration (the change will be immediate, no saving configuration is needed). For security reasons disabling both HTTP and HTTPS is not possible.

Device status

Basic

Wan config

Local network

Modem settings

Connection control

Ports configuration

TCP/IP forwarding

VLAN

Static routes

Dynamic DNS

Access control

Advanced

OpenVPN

IPsec

IPsec authentication

NTRIP

Text messages actions

E-mail actions

SNMP

Administration

Registration

Time

Syslog

User files

Configuration

Backup and restore

Discard changes

Save Settings

Access control

SSH configuration

SSH enabled	<input checked="" type="checkbox"/> Enabled <small>Set this option to enable SSH service</small>
Interfaces	<input checked="" type="checkbox"/> LAN1 <input type="checkbox"/> WIFI <input type="checkbox"/> GSM <input checked="" type="checkbox"/> OpenVPN <input type="checkbox"/> IPsec <small>Choose on which interfaces SSH should be accessible</small>
OpenVPN tunnels	<input checked="" type="checkbox"/> 1 <input checked="" type="checkbox"/> 2 <input checked="" type="checkbox"/> 3 <input checked="" type="checkbox"/> 4 <small>Choose tunnels on which SSH should be accessible</small>
IPsec tunnels	<input type="checkbox"/> 1 <input type="checkbox"/> 2 <input type="checkbox"/> 3 <input type="checkbox"/> 4 <small>Choose tunnels on which SSH should be accessible</small>
SSH login as root	<input checked="" type="checkbox"/> Enabled, Port: <input type="text" value="65535"/> <small>Set this option to enable logon via SSH as root</small>
SSH root password	<input type="password" value="....."/>
SSH root key	<div style="border: 1px solid #ccc; height: 40px; width: 100%;"></div> <p><input type="button" value="Generate"/> <input type="button" value="Get private key"/> <input type="button" value="Get public key"/> <small>Paste public keys of authorized users here</small></p> <p><small>You can also generate the public key and download its private key by clicking Generate button Generating key may take up to 3 minutes, please be patient</small></p>

WWW config access configuration

Access protocols	<input checked="" type="checkbox"/> HTTP <input checked="" type="checkbox"/> HTTPS
Interfaces	<input checked="" type="checkbox"/> LAN1 <input type="checkbox"/> WIFI <input type="checkbox"/> GSM <input checked="" type="checkbox"/> OpenVPN <input type="checkbox"/> IPsec <small>Choose on which interfaces www config should be accessible</small>
OpenVPN tunnels	<input checked="" type="checkbox"/> 1 <input checked="" type="checkbox"/> 2 <input checked="" type="checkbox"/> 3 <input checked="" type="checkbox"/> 4 <small>Choose tunnels on which www config should be accessible</small>
IPsec tunnels	<input type="checkbox"/> 1 <input type="checkbox"/> 2 <input type="checkbox"/> 3 <input type="checkbox"/> 4 <small>Choose tunnels on which www config should be accessible</small>
HTTP port	<input type="text" value="80"/>
HTTPS port	<input type="text" value="443"/>

5.2.13 Open VPN

You can connect your router to a VPN network or create your own one using OpenVPN software. It is possible to create up to four VPN connections (tunnels). To view and change settings of any of tunnels select it from Tunnel configuration list under OpenVPN tab. Then choose if router should be server or client and connection type: tun or tap. Tun connection can be single- or multiclient. Depending on what you choose here, you will later need to enter client/server IP addresses or network and netmask.

If the device should be server, please enter port on which it should listen for connections (the default VPN port is 1194, remember to open the port you chose under the firewall tab). Next, please select network device on which the connection should be held: eth (external RJ45 port) or ppp (connection via mobile network). It is also necessary to choose network protocol: TCP or UDP (use the second option if you are not sure what to choose). For tun mode user should also enter server and client Ips (we advise you to use addresses from 10.x.x.x pool). For tap mode please enter VPN sub network address and net mask (for example 10.1.0.0 and 255.255.255.0). In most cases, your device will reserve first IP address from the pool (that is 10.1.0.1 if you are using 10.1.0.0 network).

If the device is set into client mode, in addition to settings same as those for server, you should input VPN server's IP in Remote Server IP field and its listening port in the Port field.

After filling in all necessary information user should fill in four certificate fields. The certificates should be generated on any PC (see VPN online help for more information). The contents of files should be pasted into appropriate fields of configuration. You can improve security of your VPN connection by entering TLS key into the TLS key field on every device in VPN network. The last setting is toggling LZ0 compression (we advise you to enable it to improve network communication) and adding extra configuration parameters in Additional configuration field.

Generating certificates:

1. We assume that RBMTX Lite will be both a server and CA (Certificate Authorization Center).
2. On the router that will work as a CA and server, select "OpenVPN mode" -> "Client".
3. Then choose "Connection mode" -> "Router (TUN) multi-client" and port (e.g. 1194).
4. We generate the certificate and the CA private key ("Generate" buttons), and then copy the CA certificate to the appropriate client device.
5. We generate a certificate and a private key for the client ("Server/client cert" and "Server/client private key"). Because the "OpenVPN mode client" was selected above, the pair will be generated for the client.
6. We also copy a client certificates pair onto the appropriate client device and then remove it from the form.
7. We change "OpenVPN mode" -> "Server" option.
8. Set the address and mask (local for the VPN connection, e.g. 10.0.0.0/255.255.255.0).

9. We generate a certificate and the server's private key.
10. We generate DH PEM.
11. Save settings.

On the client, we configure the port and protocol, and then enter the public address of the server. With the CA certificates and certificate/client pair generated on the server everything should work. You must remember that the server's certificate should be generated for the server and the client's certificate for the client. Both must be confirmed by the same (common to the server and client) CA. If all certificates are generated on RBMTX, it will simultaneously authorize both client and server certificates.

The screenshot displays the RBMTX3 Router Configuration web interface. The top navigation bar includes the TELEORIGIN logo, the title 'RBMTX3 Router Configuration', and the ELPROMA logo with the website URL 'www.teleorigin.com'. Below the navigation bar, the device information 'Modem EG91, 1 SIM, firmware: 181128' is shown. The left sidebar contains a menu with categories: 'Basic' (Device status, Wan config, Local network, Modem settings, Connection control, Ports configuration, TCP/IP forwarding, VLAN, Static routes, Dynamic DNS, Access control), 'Advanced' (OpenVPN, IPsec, IPsec authentication, NTRIP, Text messages actions, E-mail actions, SNMP), 'Administration' (Registration, Time, Syslog, User files), and 'Configuration' (Backup and restore, Discard changes). A 'Save Settings' button is located at the bottom of the sidebar. The main content area is titled 'OpenVPN tunnels' and contains the following configuration fields:

Tunnel configuration	openVPN tunnel 1 <small>Please select VPN tunnel you would like to configure</small>
OpenVPN mode	Disabled
Connection mode	Router (TUN) single-cli
Remote Server IP or domain	<input type="text"/>
Remote Server as domain name	<input type="checkbox"/> Enter Remote Server as domain name
VPN device	<input type="text"/>
NAT-T	<input type="checkbox"/> Enable NAT Traversal (NAT-T) <small>Set this option to enable the use of NAT-T (i.e. the encapsulation of ESP in UDP packets) if needed, which can help with clients that are behind restrictive firewalls.</small>
Port	<input type="text"/>
Protocol	TCP
Network	<input type="text"/>
Netmask	<input type="text"/>
Server IP	<input type="text"/>
Client IP	<input type="text"/>
CA cert	<input type="text"/> <input type="button" value="Generate"/>
CA key	<input type="text"/>

5.2.14 Ipvsec static/Ipvsec mobile

IPsec is group of internet protocols that enables user to create safe connection between devices. To configure such connection on RBMTX-Lite router you need to go through three tabs of configuration: Tunnels, Mobile Clients, Keys and Certificates. First of all, you need to enable IPsec under Tunnels tab. Below this option there is a combo box that enables you to switch between different tunnel configurations. If you want to enable specific tunnel, please select Enable tunnel checkbox. Then specify network interface on which the connection will be held. It is impossible to discuss all ways to create IPsec connection, so we have described sample configuration below.

Let's say we want to connect two RBMTX-Lite routers with following IP numbers: 123.45.67.1, 123.45.67.2. First option, DPD interval is time after which the connection is closed if the other device is not responding. You can put any value here, we will enter 3600 seconds. Then you have to choose local subnet that will be available on remote side of the connection. It can be single host, network or LAN subnet. Let's say we will be connecting more devices later so we choose network. On first router we enter following settings: IP=192.168.36.1, Network=192.168.36.0 and Netmask=255.255.255.0. The IP must be set properly according to the network and netmask. Next step is entering remote subnet. The local subnet on first device must match remote subnet on the second device and vice versa. We have specified local subnet on second router with following settings: IP=192.168.35.1, Network=192.168.35.0, Netmask=255.255.255.0, so on the first router we enter following remote subnet: Address=192.168.35.0, Netmask=255.255.255.0. After specifying local and remote subnets, you should enter remote gateway which should be other device's IP. In our case we enter 123.45.67.2 on first router and 123.45.67.1 on second one.

Afterwards we have to define first phase of the proposal. We choose negotiation mode-aggressive is less secure, but faster than main. Next setting is device's identifier. The most common setting is My IP address for PSK authentication and RSA Cert subject for RSA certificates. Now, please choose encryption, hash algorithm and DH key group-they must be the same on both sides of connection. Blowfish encryption is usually the fastest and AES is the slowest but most secure. You can optionally set lifetime of phase 1 or leave the field blank to use default value. The most important setting of phase 1 is choosing authentication method: Pre-shared key is like password, you have to enter the same key on both sides. More sophisticated authentication method is using RSA certificates, but you need to generate certificate and key for every device. You have two options here: either input other device's certificate in Peer certificate field or add CA certificate (we will cover that topic later).

In the second phase of proposal please specify the protocol (ESP is authentication with encryption, AH is authentication only), encryption algorithm, hash algorithm and PFS key group. Please note that you can choose multiple algorithms, but at least one should match on both sides of the connection. The last setting is phase 2 lifetime (leave field empty for using default value).

After configuring all settings remember to save configuration. The configuration of IPsec connection is finished unless you chose to authenticate with RSA certificates and CA certificate. In that case click on Keys and Certificates tab. Here you can add multiple Pre-shared keys and CA certificates. Adding both is similar, so we will explain only adding CA certificates. To add new one, please click on Add new button. Specify Identifier (which is used only for distinguish them in www configuration), paste CA certificate and certificate revoke list. Last field is optional and lets you ban users that shouldn't be allowed to join your network anymore.

IMPORTANT: After filling in fields click Save button and then save whole configuration by clicking Save settings. If you want to delete certificate, choose it from the list, click Delete button and then save whole configuration.

It is possible to create IPsec connection with non-static-IP-devices. In order to do this please click Mobile clients tab. Configuration is similar to the tunnel configuration, but there are less settings (for example there is no PSK field-you should add pre-shared keys for mobile clients in Keys and Certificates tab).

IMPORTANT: When configuring IPsec connection you will sometimes want to add custom routing. This topic is covered in next section.

- Device status
- Basic
 - Wan config
 - Local network
 - Modem settings
 - Connection control
 - Ports configuration
 - TCP/IP forwarding
 - VLAN
 - Static routes
 - Dynamic DNS
 - Access control
- Advanced
 - OpenVPN
 - IPsec
 - IPsec authentication
 - NTRIP
 - Text messages actions
 - E-mail actions
 - SNMP
- Administration
 - Registration
 - Time
 - Syslog
 - User files
- Configuration
 - Backup and restore
 - Discard changes

Save Settings

IPsec tunnels

Enable IPsec	<input type="checkbox"/> Enabled		
Tunnel configuration	IPsec tunnel 1 <i>Please select IPsec tunnel you would like to configure</i>		
Enable tunnel	<input type="checkbox"/> Enabled		
Local interface	Interface <input type="text" value="GSM"/>	Default route <input type="checkbox"/>	
Local subnet	Type <input type="text" value="Host only"/>	Network <input type="text"/>	Netmask <input type="text"/>
Remote host(s)	IP Address <input type="text"/>		
	Any host <input checked="" type="checkbox"/>		
	<i>Enter the public IP address of the remote host or check Any host for server role.</i>		
Remote subnet	Type <input type="text" value="Host only"/>	Network <input type="text"/>	Netmask <input type="text"/>
Connection	<input type="text" value="Always on"/>		
NAT-T	<input type="checkbox"/> Enable NAT Traversal (NAT-T) <i>Set this option to force use of NAT-T (i.e. the encapsulation of ESP in UDP packets), which can help with clients that are behind restrictive firewalls.</i>		
Phase 1 proposal (Authentication)			
Protocol	<input type="text" value="IKE v2"/>		
Change default algorithms proposal	<input type="checkbox"/> Enabled		
Encryption	<input type="checkbox"/> AES 256 <input type="checkbox"/> AES 192 <input type="checkbox"/> AES 128 <input type="checkbox"/> 3 DES	<input type="checkbox"/> Blowfish 256 <input type="checkbox"/> Blowfish 192 <input type="checkbox"/> Blowfish 128	<input type="checkbox"/> Camellia 256 <input type="checkbox"/> Camellia 192 <input type="checkbox"/> Camellia 128
Integrity	<input type="checkbox"/> SHA2 512 <input type="checkbox"/> SHA1 96	<input type="checkbox"/> SHA2 384 <input type="checkbox"/> MD5 96	<input type="checkbox"/> SHA2 256

5.2.15 Generating SSL certificates

In order to use SSL authentication creating few files and copying them into adequate fields under OpenVPN or IPsec tabs of www configuration is needed. This can be done using PC with Linux and openssl installed. There is also Windows version of software available at <http://gnuwin32.sourceforge.net/packages/openssl.htm>.

At first we need to create folder, in which all our keys and certificates will be stored. Let's say it will be ~/keys. We create two files in it: list of certificates and file enumerating them:

```
touch index.txt  
echo 00 > serial
```

and subdirectories, where the certificates and keys will be stored:

```
mkdir private certs newcerts crl
```

In order to create certificates, the certificate authority (CA) is needed . It is „main" certificate used to create other certificates. After creating private CA key:

```
openssl genrsa -des3 -out private/cakey.pem 1024
```

Warning: please remember the CA password!

The CA certificate is generated:

```
openssl req -new -x509 -days 365 -key private/cakey.pem -out cacert.pem
```

When creating a certificate user has to provide some information like country, state/province, city, company name, e-mail address and common name. The last field is most important, it has to be unique for every device.

After creating CA certificate generation of certificate for every device used is needed.

At first the private key is generated:

```
openssl genrsa -des3 -out private/device1key.pem
```

Then we generate certificate request:

```
openssl req -new -key private/device1key.pem -out device1req.pem
```

Here user has to enter country, state etc. again. They can be the same as before except the common name.

Certificate authority signs the certificate:

```
openssl ca -notext -in device1req.pem -out device1cert.pem
```

If certificate will be used on RBMTX-Lite router, password on private key has to be disabled:

```
openssl rsa -in private/device1key.pem -out private/device1key.pem_nopass
```

The whole process is repeated for every device (unique common names and filenames have to be unique for different devices!).

If IPsec protocol will be used, certain fields in www configuration under Ipsec/Tunnels tab have to be filled in. Content of *device1cert.pem* file should be pasted into the Certificate field and contents of *device1key.pem_nopass* into the Key field. Peer Certificate field can be filled with another device's certificate file or left empty. In this case the CA certificate has to be provided under Keys and Certificates tab. Contents of *cacert.pem* file should be inserted there.

If the OpenVPN protocol will be used, under OpenVPN tab content of *cacert.pem* has to be pasted into CA cert field, content of *device1cert.pem* into Server/Client cert field and *device1key.pem_nopass* into Server/Client private key field. The Diffie- Hellman parameters file has to be created for VPN connection:

```
openssl dhparam -out dh1024.pem 1024
```

and its content should be copied into DH PEM field. This file is common for all devices in VPN network.

TELEORIGIN RBMTX3 Router Configuration **ELPROMA**
Modem EG91, 1 SIM, firmware: 181128 www.teleorigin.com

Keys & Certificates

IPsec secrets

Key list: [Dropdown]

[New] [Delete]
Please choose a key you would like to edit. Please note that after editing keys you have to save global settings.

Identifier: [Text Field]
Name to identify key and its value.

Key: [Text Field]
This can be: IP, FQDN, user@FQDN, %any, subnet in CIDR notation, address ranges (two addresses separated by a - without any spaces).

Key type: [Dropdown]

Key value: [Text Field]
To use certificate or key (RSA Key type) enter its Identifier.

Use own secret file: Enabled

User defined secret file: [Text Field]
Enter name of uploaded secrets file.

View generated secrets file: [View]
If you enable IPsec after Save settings you can view generated ipsec.secrets

Keys & Certs

Keys & certs list: [Dropdown]

[New] [Delete]
Please choose a certificate you would like to edit. Please note that after editing certificates you have to save global settings.

Identifier: [Text Field]
Please enter any name/Identifier

[Save Settings]

5.2.16 NTRIP configuration page

One of /dev/ttyS0 port modes is communication with external device using NTRIP protocol. If you decide to use it, it is necessary to set the mode under RS232 Port configuration page. Then, enter settings in NTRIP page. Server address, port and initial position fields are necessary. Username and passwords are optional.

It is also possible to choose data request mode. After entering required data, please click Get List button to download data streams list from the server – it may take a while, please be patient. After downloading the list please select one of data streams.

Attention: Entering initial position is necessary to login to NTRIP server if no external device sending NMEA frames is connected to the S0 port.

The screenshot shows the 'RBMTX3 Router Configuration' interface. At the top, it displays 'Modem EG91, 1 SIM, firmware: 181128' and the 'ELPROMA' logo with the website 'www.teleorigin.com'. The left sidebar contains a navigation menu with categories: 'Device status', 'Basic' (Wan config, Local network, Modem settings, Connection control, Ports configuration, TCP/IP forwarding, VLAN, Static routes, Dynamic DNS, Access control), 'Advanced' (OpenVPN, IPsec, IPsec authentication), 'NTRIP' (highlighted), 'Text messages actions', 'E-mail actions', 'SNMP', 'Administration' (Registration, Time, Syslog, User files), and 'Configuration' (Backup and restore, Discard changes). A 'Save Settings' button is at the bottom of the sidebar.

The main content area is titled 'NTRIP' and contains the following configuration fields:

- NTRIP:** Enabled. *Set this option to enable NTRIP service*
- Server address:**
- Port:**
- Username:**
- Password:**
- Initial position:** Enabled. *Set this option to enable login to NTRIP server with fixed position. Use this option when there is no external source of NMEA frames connected via RS232.*
- Latitude:** ° ' "
- Longitude:** ° ' "
- Data request mode:**
- Mountpoint:**

5.2.17 Text messages actions

Text messages (SMS) actions tab allows user to define shell scripts that will be executed every time router receives SMS with specified content.

To enable this option ensure that global SMS Actions checkbox is enabled and you have set one of available ports into SMS receiving mode under Ports configuration tab. Then click New button, enter any identifier and command-sms content that will trigger action. You can write any shell script you want and/or set GPIO action to be executed.

The screenshot displays the RBMTX3 Router Configuration web interface. The top navigation bar includes the TELEORIGIN logo, the router model 'RBMTX3 Router Configuration', and the ELPROMA logo. Below the navigation bar, the page title is 'Text messages actions'. The interface is divided into several sections:

- Text messages (SMS) server:** Includes a 'Management' section with links for 'Incoming text messages (SMS)', 'Sent text messages (SMS)', 'Report text messages (SMS)', and 'Help'.
- Text messages (SMS) configuration:** Features an 'Enabled' checkbox, which is currently checked.
- Text messages (SMS) actions:** This section contains a table for managing actions. The table has a header 'Text messages (SMS) actions list' and a dropdown menu showing 'SMSback my IP'. Below the table are 'New' and 'Delete' buttons. A note states: 'Please choose action you would like to edit. Please note that after editing rules you have to save global settings.'
- Identifier:** A text input field containing 'SMSback my IP' with the instruction 'Please enter any identifier'.
- Command:** A text input field containing 'Myip' with the instruction 'Please enter command (content of text message)'.
- Script:** A text area containing a shell script:

```
#!/bin/bash  
smssend.sh $SMS_SENDER "GSM IP: $(myip gsm); LAN  
IP: $(myip lan)"
```

 Below the script is the instruction: 'This script will be executed after receiving text message (SMS) command'.

At the bottom left of the interface, there is a 'Save Settings' button.

5.2.18 E-mail actions

In the “E-mail Actions” section, the user can set up an e-mail account for sending messages (set the parameters: recipient, sender, server address, port, user and password). It is also possible to set up a script that will be launched automatically (messages can be sent with attachments or not, it is possible to compress the file before sending).



RBMTX3 Router Configuration
Modem EG91, 1 SIM, firmware: 181128



www.teleorigin.com

Device status

Basic

Wan config

Local network

Modem settings

Connection control

Ports configuration

TCP/IP forwarding

VLAN

Static routes

Dynamic DNS

Access control

Advanced

OpenVPN

IPsec

IPsec authentication

NTRIP

Text messages actions

E-mail actions

SNMP

Administration

Registration

Time

Syslog

User files

Configuration

Backup and restore

Discard changes

Save Settings

E-mail Actions

E-mail configuration

E-mail sending	<input type="checkbox"/> Enabled <small>Set this option if you want to allow router send e-mails.</small>
Recipient	<input type="text"/> <small>All messages will be delivered to this e-mail address</small>
From:	<input type="text"/> <small>Enter "From:" field of e-mails here e.g. "me@example.com"</small>
Host name	<input type="text"/> <small>Enter host name here e.g. "smtp.gmail.com"</small>
Port	<input type="text"/> <small>Enter port number here e.g. "587"</small>
Username	<input type="text"/> <small>Enter your username of e-mail service</small>
Password	<input type="text"/> <input type="text"/> (confirmation) <small>Enter password from your e-mail service twice</small>

E-mail Actions

E-mail actions list	<input type="text" value=""/> <div style="display: flex; justify-content: space-around; margin-top: 5px;"> New Delete </div> <small>Please choose action you would like to edit. Please note that after editing rules you have to save global settings.</small>
Identifier	<input type="text"/> <small>Please enter any identifier</small>
Date (Month/Day of month) of script execution	<input type="text" value=""/> <input type="text" value=""/> <small>Please enter month(s) and day(s) of month(s) when script will be executed. Ranges can be defined with dashes e.g. "1-15", you can also use commas e.g. "1,6,7". Note, that using "*" replaces all months/days, and "1-12/2" means "every 2 months/days from range 1-12 (2,4,6,...)"</small>

5.2.19 SNMP

TELEORIGIN
UNIQUE TECHNOLOGY FOR TELEMTRY

RBMTX3 Router Configuration ELPROMA
Modem EG91, 1 SIM, firmware: 181128 www.teleorigin.com

- Device status
- Basic
 - Wan config
 - Local network
 - Modem settings
 - Connection control
 - Ports configuration
 - TCP/IP forwarding
 - VLAN
 - Static routes
 - Dynamic DNS
 - Access control
- Advanced
 - OpenVPN
 - IPsec
 - IPsec authentication
 - NTRIP
 - Text messages actions
 - E-mail actions
- SNMP**
- Administration
 - Registration
 - Time
 - Syslog
 - User files
- Configuration
 - Backup and restore
 - Discard changes

SNMP

Enabled
Set this option to enable SNMP service.

RBMTX MIB file [Download](#)

SNMP networking

Protocol & Port
Protocol: Port:

Interfaces
 LAN
 WIFI
 GSM
Choose on which interfaces SNMP should be accessible

SNMP information

System location
Set description of system location

Administrator contact
Set contact information to system administrator

SNMP users

Username

[New](#) [Delete](#)
Please choose a username you would like to edit. Please note that after editing you have to save global settings.

Username & access type
Access type: Username:

Authentication
Protocol: Password: Confirm password:

Encryption
Protocol: Password: Confirm password:

[Save Settings](#)

5.2.20 Time

Here you can manually set hardware clock or input IP of NTP server to synchronize time automatically



UNIQUE TECHNOLOGY FOR TELEMTRY

RBMTX3 Router Configuration

Modem EG91, 1 SIM, firmware: 181128



www.teleorigin.com

Device status

Basic

Wan config

Local network

Modem settings

Connection control

Ports configuration

TCP/IP forwarding

VLAN

Static routes

Dynamic DNS

Access control

Advanced

OpenVPN

IPsec

IPsec authentication

NTRIP

Text messages actions

E-mail actions

SNMP

Administration

Registration

Time

Syslog

User files

Configuration

Backup and restore

Discard changes

[Save Settings](#)

NTP

RTC time (UTC) 2019-01-16 15:01:48

NTP Peer 1 preferred server Enabled Enter NTP Server as domain name
Enter IP address NTP server

NTP Peer 2 server Enabled Enter NTP Server as domain name
Enter IP address NTP server

NTP Peer 3 server Enabled Enter NTP Server as domain name
Enter IP address NTP server

Set Date(Y/M/D) and Time(h:m:s) [Set](#)
Please enter date/time below and press Set button

NTP Status

s	remote	refid	st	t	when	pool	reach	delay	offset	jitter
*	212.110.158.28	89.109.251.21	2	u	27	1024	377	100.079	-0.936	1.806
+	tkswf.friesenec	.GPS.	1	u	36	1024	377	85.498	-4.783	1.421

5.2.21 Syslog

Here you can define how router should save your logs. Router has internal memory that get overwritten when it reaches its end. You can also save logs on your computer by clicking download (manually). It is also possible to get remote access to logs by enabling Remote service and setting SYSLOG host.

The screenshot displays the 'RBMTX3 Router Configuration' web interface. The top navigation bar includes the 'TELEORIGIN' logo, the title 'RBMTX3 Router Configuration', the 'ELPROMA' logo, and the website 'www.teleorigin.com'. Below the navigation bar, the device status is shown as 'Modem EG91, 1 SIM, firmware: 181128'. The left sidebar contains a menu with categories: 'Device status', 'Basic' (Wan config, Local network, Modem settings, Connection control, Ports configuration, TCP/IP forwarding, VLAN, Static routes, Dynamic DNS, Access control), 'Advanced' (OpenVPN, IPsec, IPsec authentication, NTRIP, Text messages actions, E-mail actions, SNMP), 'Administration' (Registration, Time, Syslog, User files), and 'Configuration' (Backup and restore, Discard changes). The 'Syslog' menu item is highlighted in red. The main content area is titled 'SYSLOG' and contains several configuration sections: 'Local service log' with 'View' and 'Download' buttons; 'Remote service' with an 'Enabled' checkbox and a note 'If this option is set, device will store system logs on remote host'; 'SYSLOG host' with an input field and the instruction 'Enter SYSLOG host IP address here'; 'SYSLOG host as domain name' with an 'Enter SYSLOG host as domain name' checkbox; and 'Heartbeat' with a 'Send' button. A 'Save Settings' button is located at the bottom of the sidebar.

5.2.22 User files

You can upload to the router your own scripts and executable files and set them to be used in certain situations (e.x. when the VPN connection is established or at router startup). Under User files tab there is a list of user files. It is refreshed automatically after selecting tab, it can be also manually refreshed by pressing Refresh button. To delete file, select it from the list and press Delete button. To upload file, click Upload new button. You will be redirected to separate site. Choose file by pressing Browse... button and commit your choice by clicking Upload. After upload you will be informed if the whole operation was successful or the error message will be displayed. Use link to return to the main page of www configuration. All files are stored with rights for file execution, so they can be used in scripts.

Below the file upload panel there are two fields, where you can write scripts. Startup script will be executed after startup procedure of router and Reconfiguration script every time you click Save Configuration button in www configuration. You can write your scripts in Bash or PHP, but remember to use special header for scripts ((#!/bin/bash lub #!/usr/bin/php)). You can execute uploaded user files, they are stored in /root/userfiles.

WARNING: Binary files uploaded to router should be compiled for processor installed in router!

The screenshot displays the RBMTX3 Router Configuration web interface. At the top, the header includes the TELEORIGIN logo, the title 'RBMTX3 Router Configuration', the ELPROMA logo, and the website URL 'www.teleorigin.com'. Below the header, the device information is shown: 'Modem EG91, 1 SIM, firmware: 181128'. The left sidebar contains a navigation menu with categories: Device status, Basic, Advanced, Administration, and Configuration. The 'User files' tab is selected and highlighted in red. The main content area is titled 'User files' and is divided into two sections: 'Files upload' and 'Scripts'. The 'Files upload' section features a 'User files list' dropdown menu, three buttons labeled 'Refresh', 'Delete', and 'Download', and a 'Select File:' field with a 'Wybierz plik' button. Below this is an 'Upload' button and a note: 'Files are stored in /root/userfiles/. You can delete files by choosing one from list and clicking Delete button'. The 'Scripts' section contains two text input fields: 'Startup script' and 'Reconfiguration script'. Below the 'Startup script' field is a note: 'This script will be executed after boot-up procedure'. Below the 'Reconfiguration script' field is a note: 'This script will be executed after reconfiguration procedure (changing settings via www configuration)'. At the bottom of the sidebar, there is a 'Save Settings' button.

5.2.23 Backup and restore

Under backup and restore tab user can:

- Save/load alternative configurations
- Configure FTP client to periodically check FTP server for latest configuration
- Download/Upload backup configuration

TELEORIGIN RBMTX3 Router Configuration **ELPROMA**
Modem EG91, 1 SIM, firmware: 181128 www.teleorigin.com

Backup and upgrade

Alternative configurations

Configuration list: <<unused>>

Configuration name: <<unused>>

Buttons: Delete, Save, Load

Here you can save/load alternative configuration files

Downloading configuration from FTP

FTP configuration daemon: Enabled

URL:
Please enter full FTP path to compressed configuration file, e.x. ftp://192.168.1.1/configuration.tar.bz2

Username:

Password:

Force SSL connection: Enabled
FTP server has to support SSL.

Check interval:
Enter interval in seconds between FTP checks or leave the field empty to use the default value (60).

Upload current configuration to FTP:

Download configuration

Here you can download your current configuration for later use.

Upload configuration

Select File: Nie wybrano pliku

5.2.24 Discard changes

Discard current changes in configuration which were not saved yet.

5.2.25 Save settings

To save your settings click save setting and wait until message will show up to confirm your configuration data was saved.

5.3 System logs description

This paragraph shows structure of typical System log with some basic errors:

```
01/01/0000:00:30 rbmtx-lite syslogd 1.4.1: restart.
01/01/0000:00:31 rbmtx Start: RBMTX-Lite - FIRM:171026 – modem and firmware info
01/01/0000:00:35 rbmtx supervisor[560]: SIM Holder open/closed – SIM holder open/closed by software
01/01/0000:00:36 rbmtx supervisor[560]: Modem init 1 – first initialization try
01/01/0000:01:09 rbmtx supervisor[560]: Init /dev/ttyS1 – port initialization
01/01/0000:01:10 rbmtx supervisor[560]: Init /dev/ttyACM0
01/01/0000:01:13 rbmtx supervisor[560]: Modem is not registered on the GSM network – modem is not able to log into network
01/01/0000:01:13 rbmtx supervisor[560]: Entering Modem is ready
01/01/0000:01:13 rbmtx supervisor[560]: Entering PIN OK – modem is ready for connection
01/01/0000:01:13 rbmtx supervisor[560]: Entering PIN error code: - wrong PIN message
01/01/0000:01:14 rbmtx login[811]: unable to change tty `/dev/ttyS0' for user `root'
01/01/0000:01:14 rbmtx login[811]: ROOT LOGIN on `ttyS0'
01/01/0000:01:20 rbmtx pppd[901]: pppd 2.4.5 started by root, uid 0 – connection
01/01/0000:01:21 rbmtx chat[903]: timeout set to 2 seconds
01/01/0000:01:21 rb chat[903]: send (AT)
01/01/0000:01:21 rbmtx chat[903]: expect (OK)
01/01/0000:01:21 rbmtx chat[903]: AT
01/01/0000:01:21 rbmtx chat[903]: OK
01/01/0000:01:21 rbmtx chat[903]: send (ATZ0)
01/01/0000:01:21 rbmtx chat[903]: expect (OK)
01/01/0000:01:21 rbmtx chat[903]: ATZ0
01/01/0000:01:21 rbmtx chat[903]: OK
01/01/0000:01:21 rbmtx chat[903]: send (AT)
01/01/0000:01:21 rbmtx chat[903]: abort on (NO DIALTONE)
01/01/0000:01:21 rbmtx chat[903]: abort on (ERROR)
01/01/0000:01:21 rbmtx chat[903]: abort on (NO ANSWER)
01/01/0000:01:21 rbmtx chat[903]: abort on (BUSY)
01/01/0000:01:21 rbmtx chat[903]: expect (OK)
01/01/0000:01:21 rbmtx chat[903]: AT
01/01/0000:01:21 rbmtx chat[903]: OK
01/01/0000:01:21 rbmtx chat[903]: send (ATZ0)
01/01/0000:01:21 rbmtx chat[903]: abort on (NO CARRIER)
01/01/0000:01:21 rbmtx chat[903]: timeout set to 30 seconds
01/01/0000:01:21 rbmtx chat[903]: expect (OK)
01/01/0000:01:21 rbmtx chat[903]: ATZ0
01/01/0000:01:21 rbmtx chat[903]: OK
01/01/0000:01:21 rbmtx chat[903]: send (AT)
01/01/0000:01:21 rbmtx chat[903]: expect (OK)
01/01/0000:01:21 rbmtx chat[903]: AT
01/01/0000:01:21 rbmtx chat[903]: OK
01/01/0000:01:21 rbmtx chat[903]: send (AT+CGDCONT=1,"ip","example.apn")
01/01/0000:01:22 rbmtx chat[903]: clear abort on (ERROR)
01/01/0000:01:22 rbmtx chat[903]: send (dddATD*99#)
01/01/0000:01:23 rbmtx supervisor[560]: pppd check loop:1
01/01/0000:01:25 rbmtx chat[903]: expect (CONNECT)
01/01/0000:01:25 rbmtx chat[903]: AT+CGDCONT=1,"ip","example.apn"
```

5.4 Elproma Device Manager

Elproma Device Manager is an application which allows you to find RBMTX-Lite routers in local area network (LAN) and then restore factory settings by entering their IMEI number. It is particularly useful when you forgot IP number of device and you can't access it by router on serial port.

The installation process is pretty simple. On Windows system – unpack the file from [EDM-native](#) and then launch EDM.exe. Linux version is available here: [edm](#). The main window of program consists of table-list of devices available on your network and buttons: Scan, Clear List and Reset. First you need to scan the network for devices. It takes few seconds to list all the devices. Please also keep in mind that it takes a while to boot router so it won't respond immediately after you turn it on.

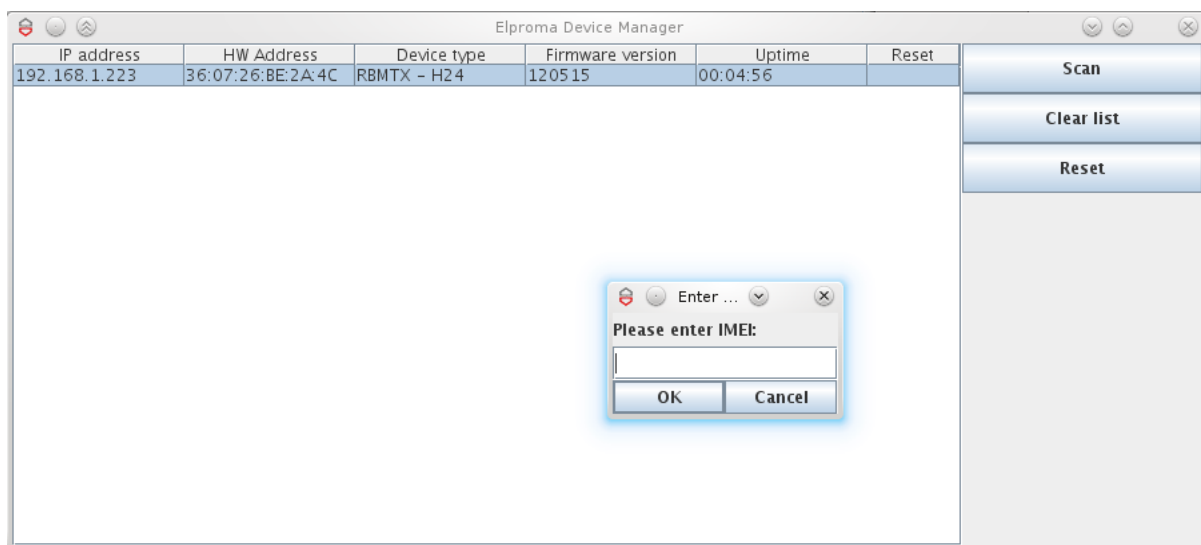
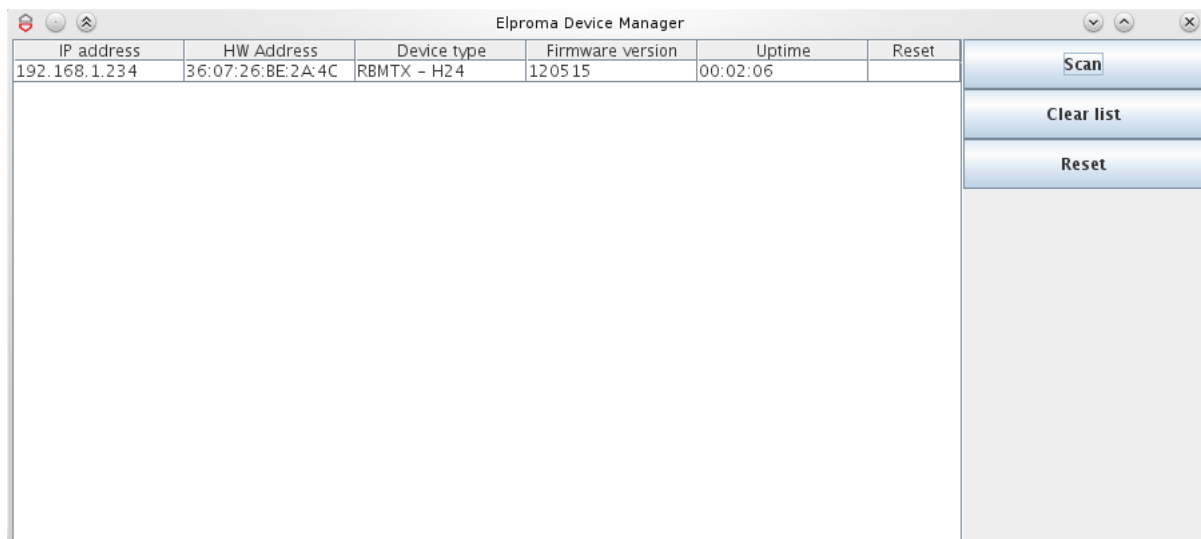

When the scan is complete you can see list of available devices in the table. You can review information like IP address, MAC address, device name, firmware version and uptime. If you want to restore factory settings on any device on the list, click the Reset button and enter IMEI. Program will send special packet to all devices, but only the one with IMEI you have entered will be affected. If the IMEI is correct and the factory settings have been restored you should see „IMEI OK" in one of cells of last column. This device will now reset to load new settings and after about 1-2 minutes it will confirm that whole operation was successful - you should see then that „IMEI OK" will change to „done".

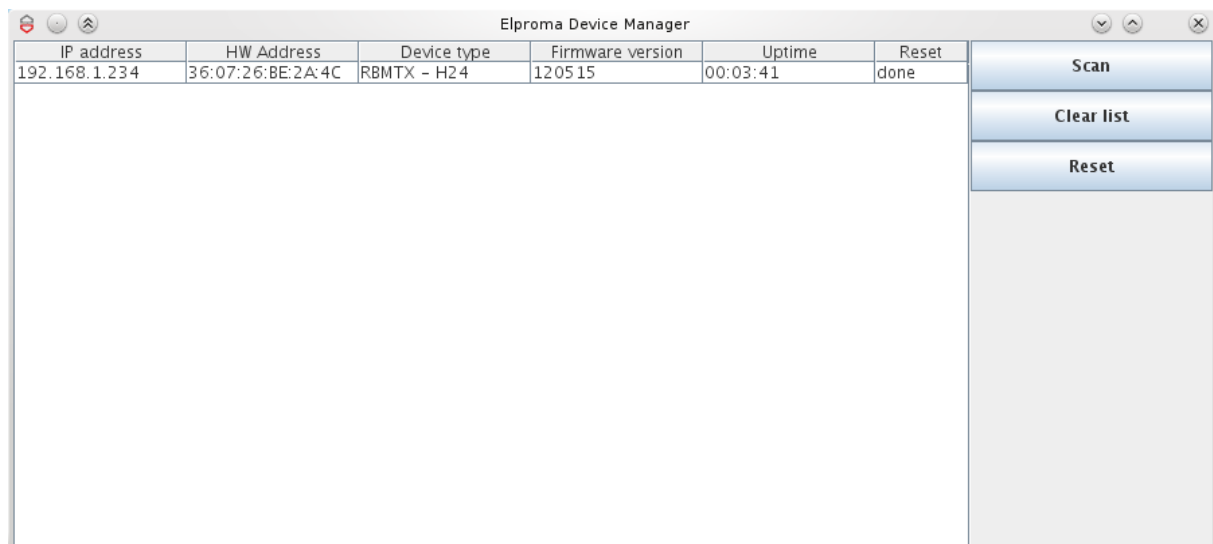
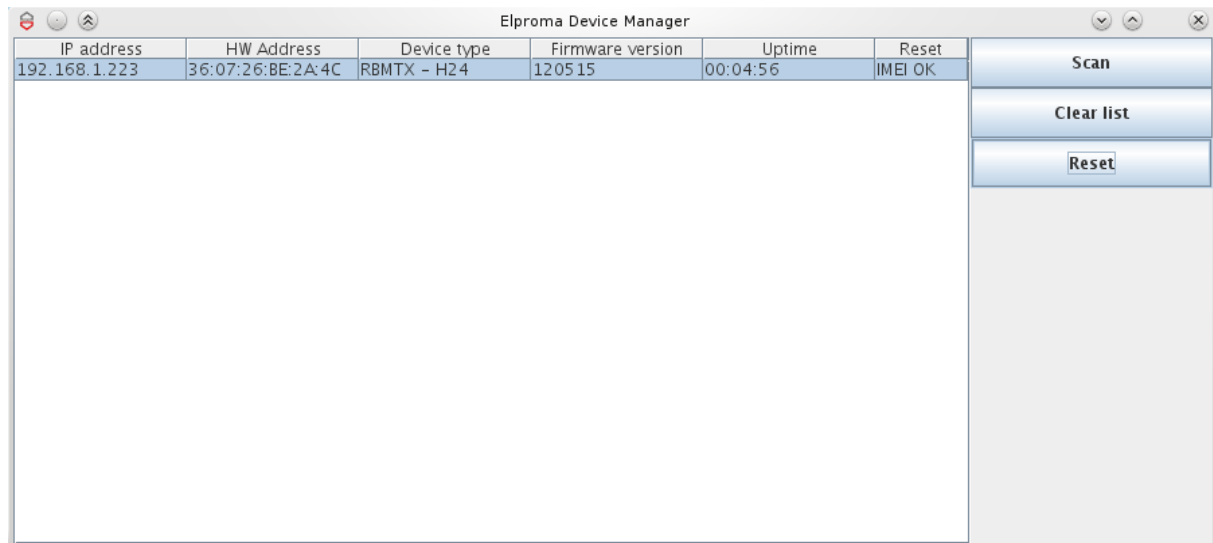

6 Troubleshooting

6.1 No communication with the router

If there is no communication with the router do the following steps:

- Check all external connections of the router
- Verify if power supply is correct
- Check if TCP/IP parameters are correct
- Check if any firewall is not blocking connection with the router
- Reset the router to default values by pressing the reset button (marked with the R letter) for 3 seconds

6.2 Router answers but there is no internet connection

If there is no internet connection do the following:

- Check if antenna is connected properly
- Check if you have reception of GPRS/UMTS/LTE signal in your area (on website of GSM provider)
- Check if you configured your router with proper parameters provided by your network provider (they should match in order to connect to internet)
- In case you do not have internet access contact your provider in order to get internet access

7 Technical characteristics

7.1 Mechanical characteristic

Max. dimensions	72 x 53.5 x 26 mm (w/o connectors)
Weight	≈90 g (only router w/o any external connection)
Volume	≈100 cm ³ (w/o connectors)

7.2 Housing (dimension diagram)

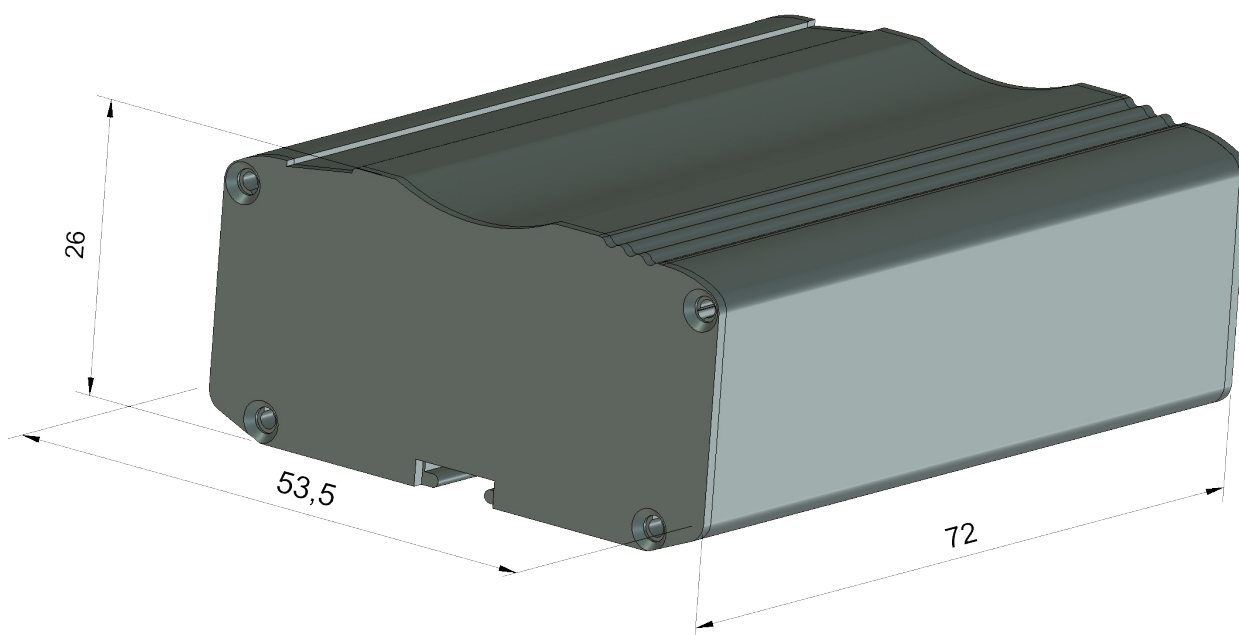

7.3 Electrical characteristic

7.3.1 Power supply

- Nominal voltage range: 9V-30V
- Maximum continuous (average) supply power: 5W
- Peak (momentary) supply current: 1A

7.3.2 RF characteristics

7.3.2.1 Frequency ranges – UMTS/HSPA variant

Band	Receive	Transmit	Unit
EGSM900	925 ~ 960	880 ~ 915	MHz
DCS1800	1805 ~ 1880	1710 ~ 1785	MHz
UMTS2100	2110 ~ 2170	1920 ~ 1980	MHz
UMTS1900	1930 ~ 1990	1850 ~ 1910	MHz
UMTS900	925 ~ 960	880 ~ 915	MHz
UMTS850	869 ~ 894	824 ~ 849	MHz

7.3.2.2 Frequency ranges - LTE variant

3GPP Band	Transmit	Receive	Unit
EGSM900	880~915	925~960	MHz
DCS1800	1710~1785	1805~1880	MHz
WCDMA B1	1920~1980	2110~2170	MHz
WCDMA B2	1850~1910	1930~1990	MHz
WCDMA B4	1710~1755	2110~2155	MHz
WCDMA B5	824~849	869~894	MHz
WCDMA B8	880~915	925~960	MHz
LTE-FDD B1	1920~1980	2110~2170	MHz
LTE FDD B2	1850~1910	1930~1990	MHz
LTE-FDD B3	1710~1785	1805~1880	MHz
LTE FDD B4	1710~1755	2110~2155	MHz
LTE FDD B5	824~849	869~894	MHz
LTE-FDD B7	2500~2570	2620~2690	MHz
LTE-FDD B8	880~915	925~960	MHz
LTE FDD B12	699~716	729~746	MHz
LTE FDD B13	777~787	746~756	MHz
LTE-FDD B20	832~862	791~821	MHz
LTE-FDD B28A	703~733	758~788	MHz

7.3.2.3 WiFi characteristics

Standards	802.11b/g/n
Frequency band	2.4 Ghz
Output power	13 dBm@11n 17 dBm@11b 15 dBm@11g tolerance ± 2 dBm.
Data rates:	up to 150Mbps

7.3.2.4 External antenna

The external antenna is connected to the router via SMA connector. Antenna must have parameters as shown below in table.

Antenna frequency range	Supporting GSM, UMTS or LTE frequencies for GSM or ISM 2.4 GHz for WIFI
Impedance	50 Ω
DC impedance	0 Ω
Gain	0 dBi
VSWR (with cable)	-10 dB

The antenna chosen for working with router should best fit to circumstances of environment it is used in. When the router is placed in a room or somewhere where the range of networks signal is too low, the outdoor or specific indoor antenna should be used to increase it.

7.4 Environmental characteristic

Attention! Exceeding the values may result in permanent damage to the module.

Parameter	Min	Max	Unit
Ambient Operating Temperature	-20	60	°C

8 Router architecture

Diagram below shows simplified architecture of RBMTX-Lite. Features marked with dotted lines are available as option

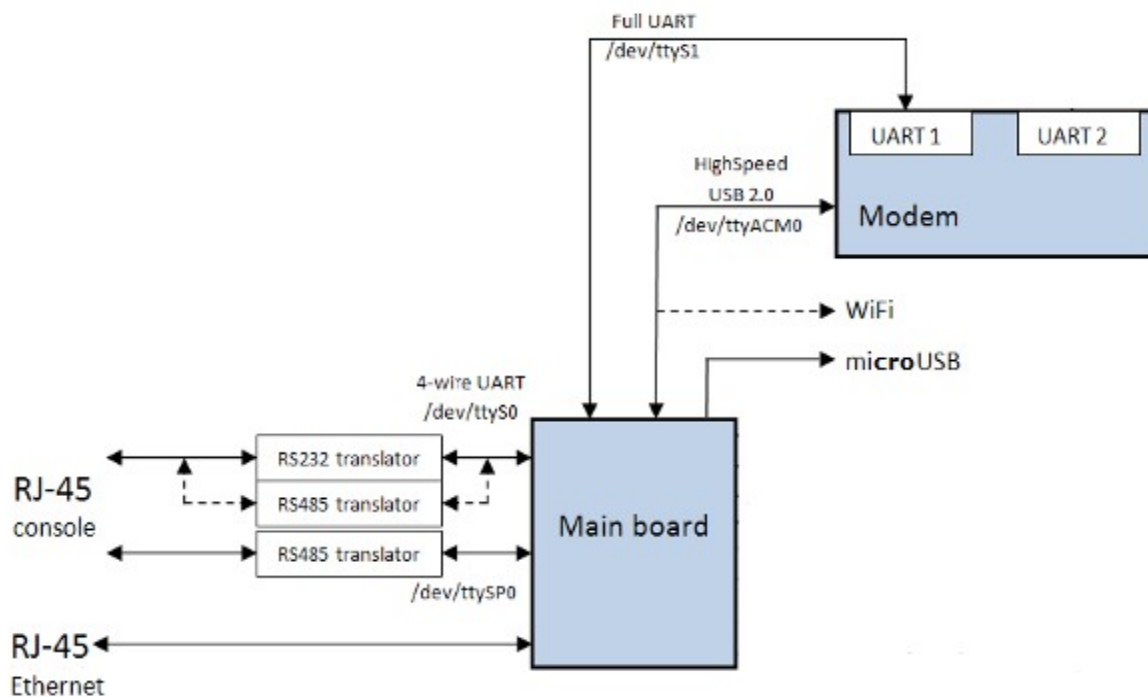

9 Safety recommendations

9.1 General Safety

Please follow safety regulations regarding the use of radio equipment due to the possibility of radio frequency interference. Read given advices carefully.

Switch **off** GSM router when:

- in an aircraft – using cellular telephones in aircraft may endanger the operation of the aircraft; it is illegal
- at a refuelling point
- in any area with potentially explosive atmosphere which could cause an explosion or fire
- in hospitals and any other places where medical equipment is in use

Respect restrictions on the use of radio equipment in any area or place where it is signaled that using cellular telephony is forbidden or dangerous.

Using GSM modem close to other electronic equipment may also cause interference if the equipment is inadequately protected. It may lead to damage or failure of GSM modem or the other equipment.

9.2 Care and Maintenance

The RBMTX-Lite router is a electronic product that should be treated with care. Please follow suggestions shown below due to using router for many years.

- Do not expose router to any extreme circumstances like high temperature or high humidity
- Do not keep router in dirty and dust places
- Do not disassemble the router
- Do not expose the router to any water, rain or steam
- Do not drop, shake or knocking your router
- Do not place your router close to magnetic devices – credit cards, etc
- Use of third party equipment or accessories, not made or authorized by Elproma Elektronika Sp. z o.o. may invalid the warranty of router and/or cause failure or permanent damage of router
- Do not expose the router to children under 3 years

9.3 Responsibility

The router is under your responsibility. Please treat it with care, and respect local regulations. This is not a toy – keep it out of the reach of children.

Try to use security features (PIN etc.) to block unauthorized use or theft.

10 Accessories

The tables below shows recommended accessories for RBMTX-Lite router.

Part No.	Name	Description
RB-PS12VP2L15	12V power adaptor	<1,5m> 2 PIN
RB-PSCP2L15	Supply cable	2PIN <1,5m> open end
RB-904G	GSM/UMTS/LTE antenna	2J011
RB-89MSH	SIM drawer	MOLEX0912360001
RB-MDI	DIN Holder	
RB-MR2R4	RS232/RS485 2in1 cable	

Power cable - open end

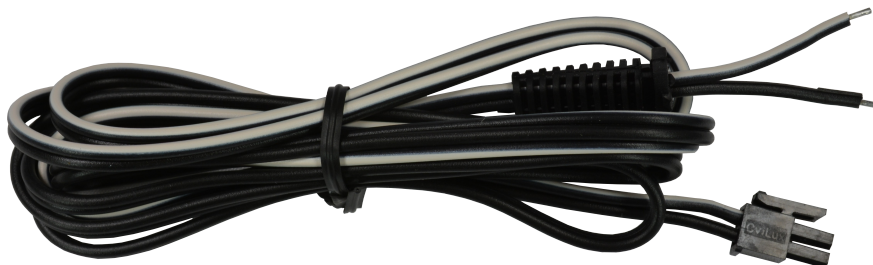

RS232/485 cable



11 Safety Recommendations

READ CAREFULLY

Be sure the use of this product is allowed in the country and in the environment required. The use of this product may be dangerous and has to be avoided in the following areas:

- Where it can interfere with other electronic devices in environments such as hospitals, airports, aircrafts, etc
- Where there is risk of explosion such as gasoline stations, oil refineries, etc

It is responsibility of the user to enforce the country regulation and the specific environment regulation.

Do not disassemble the product; any mark of tampering will compromise the warranty validity.

We recommend following the instructions of the hardware user guides for a correct wiring of the product. The product has to be supplied with a stabilized voltage source and the wiring has to be conforming to the security and fire prevention regulations.

The product has to be handled with care, avoiding any contact with the pins because electrostatic discharges may damage the product itself. The same cautions have to be taken for the SIM, checking carefully the instruction for its use. Do not insert or remove the SIM when the product is in power saving mode.

The system integrator is responsible of the functioning of the final product; therefore, care has to be taken to the external components of the module, as well as of any project or installation issue, because the risk of disturbing the GSM network or external devices or having impact on the security. Should there be any doubt, please refer to the technical documentation and the regulations in force.

Every module has to be equipped with a proper antenna with specific characteristics. The antenna has to be installed with care in order to avoid any interference with other electronic devices and has to guarantee a minimum distance from the people (20 cm). In case of this requirement cannot be satisfied, the system integrator has to assess the final product against the SAR regulation.

1. The unit does not provide protection from lightning and surge. For outdoor installation use outdoor nonmetallic case safety approved according UL 50. Additionally you should provide protection from lightning and over voltage according National code.

2. Be sure the use of this product is allowed in the country and in the environment required. The use of this product may be dangerous and has to be avoided in the following areas: Where it can interfere with other electronic devices in environments such as hospitals, airports, aircrafts, etc. Where there is risk of explosion such as gasoline stations, oil refineries, etc. It is responsibility of the user to enforce the country regulation and the specific environment regulation. Do not disassemble the product; any mark of tampering will compromise the warranty validity. We recommend following the instructions of the hardware user guides for a correct wiring of the product. The product has to be supplied with a stabilized voltage source and the wiring has to be conforming to the security and fire prevention regulations. The product has to be handled with care, avoiding any contact with

the pins because electrostatic discharges may damage the product itself. Same cautions have to be taken for the SIM, checking carefully the instruction for its use. Do not insert or remove the SIM when the product is in power saving mode. The system integrator is responsible of the functioning of the final product; therefore, care has to be given to the external components of the unit, as well as of any project or installation issue, because the risk of disturbing the GSM network or external devices or having impact on the security. Should there be any doubt, please refer to the technical documentation and the regulations in force. Every unit has to be equipped with a proper antenna with specific characteristics. The antenna has to be installed with care in order to avoid any interference with other electronic devices and has to guarantee a minimum distance from the body (20 cm/8"). In case this requirement cannot be satisfied, the system integrator should assess the final product against the SAR regulation. The European Community provides some Directives for the electronic equipment introduced on the market. All the relevant information and the text of the Directive 2014/53/EU (RED) regarding telecommunication equipment are available at the European Commission website: http://ec.europa.eu/growth/sectors/electrical-engineering/red-directive_en

12 Certifications

12.1 Conformity Assessment Issues

The RBMTX-Lite has been assessed in order to satisfy the essential requirements of the RED Directive 2014/53/EU (Radio Equipment Directive) to demonstrate the conformity against the harmonised standards with the final involvement of a Notified Body.



12.2 Declatarions of conformity

The RBMTX-Lite product is in conformity with the following standards or other normative documents:

12.3 National restrictions

This device is intended for use in all EU countries (and other countries following the EU directive 2014/53/EU) without any limitation except for the countries mentioned below:

Norway	This subsection does not apply for the geographical area within a radius of 20 km from the centre of Ny-Ålesund
--------	---

13 List of Acronyms

ACM	Accumulated Call Meter
ASCII	American Standard Code for Information Interchange
AT	Attention commands
CB	Cell Broadcast
CBS	Cell Broadcasting Service
CCM	Call Control Meter
CLIP	Calling Line Identification Presentation
CLIR	Calling Line Identification Restriction
CMOS	Complementary Metal-Oxide Semiconductor
CR	Carriage Return
CSD	Circuit Switched Data
CTS	Clear To Send
DAI	Digital Audio Interface
DCD	Data Carrier Detected
DCE	Data Communications Equipment
DRX	Data Receive
DSR	Data Set Ready
DTA	Data Terminal Adaptor
DTE	Data Terminal Equipment
DTMF	Dual Tone Multi Frequency
DTR	Data Terminal Ready
EMC	Electromagnetic Compatibility
ETSI	European Telecommunications Equipment Institute
FTA	Full Type Approval (ETSI)
GPRS	General Radio Packet Service
GSM	Global System for Mobile communication
HF	Hands Free
IMEI	International Mobile Equipment Identity
IMSI	International Mobile Subscriber Identity
IRA	Internationale Reference Alphabet
ITU	International Telecommunications Union
IWF	Inter-Working Function
LCD	Liquid Crystal Display

LED	Light Emitting Diode
LF	Linefeed
ME	Mobile Equipment
MMI	Man Machine Interface
MO	Mobile Originated
MS	Mobile Station
MT	Mobile Terminated
OEM	Other Equipment Manufacturer
PB	Phone Book
PDU	Protocol Data Unit
PH	Packet Handler
PIN	Personal Identity Number
PLMN	Public Land Mobile Network
PUCT	Price per Unit Currency Table
PUK	PIN Unblocking Code
RACH	Random Access Channel
RLP	Radio Link Protocol
RMS	Root Mean Square
RTS	Ready To Send
RI	Ring Indicator
SAR	Specific Absorption Rate (e.g. of the body of a person in an electromagnetic field)
SCA	Service Center Address
SIM	Subscriber Identity Module
SMD	Surface Mounted Device
SMS	Short Message Service
SMSC	Short Message Service Center
SPI	Serial Protocol Interface
SS	Supplementary Service
TIA	Telecommunications Industry Association
UDUB	User Determined User Busy
USSD	Unstructured Supplementary Service Data

14 On-line support

Elproma provides a range on on-line support which includes:

- the latest version of this document
- the latest drivers for RBMTX-Lite
- technical support

This information can be found on our websites at: www.elpromaelectronics.com
or www.teleorigin.com

For further information You can contact us at:

email: info@teleorigin.com or info@elpromaelectronics.com

tel.: +48 (22) 751 76 80

fax.: +48 (22) 751 76 81



THANK YOU